

Absab
ARCHITECTURAL DESIGN

PayaRAVANKARN
Alborz

Paya Ravankaran Alborz

FUNCTION : 1) ENTRANCE DESIGN

2) INTERIOR DESIGN

3) PLANS

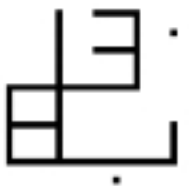

Paya Ravankaran Alborz

ENTRANCE DESIGN

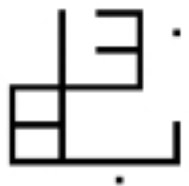

ENTRANCE DESIGN/ MAIN ENTRANCE

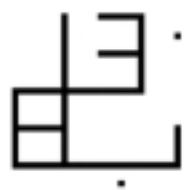

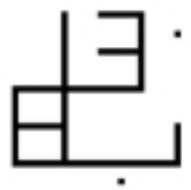

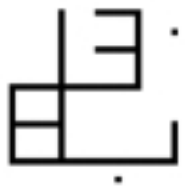

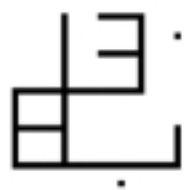

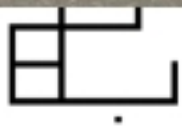

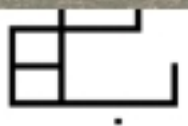

ENTRANCE DESIGN/ BUILDING ENTRANCE

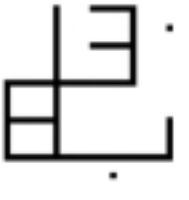

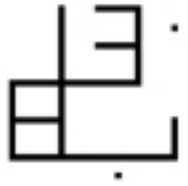

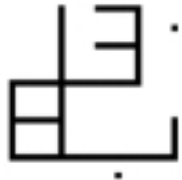

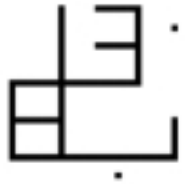

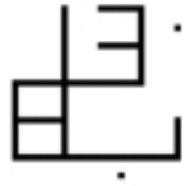

Paya Ravankaran Alborz

INTERIOR DESIGN

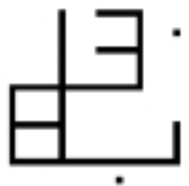

INTERIOR DESIGN/ GROUND FLOOR

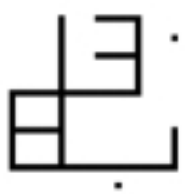
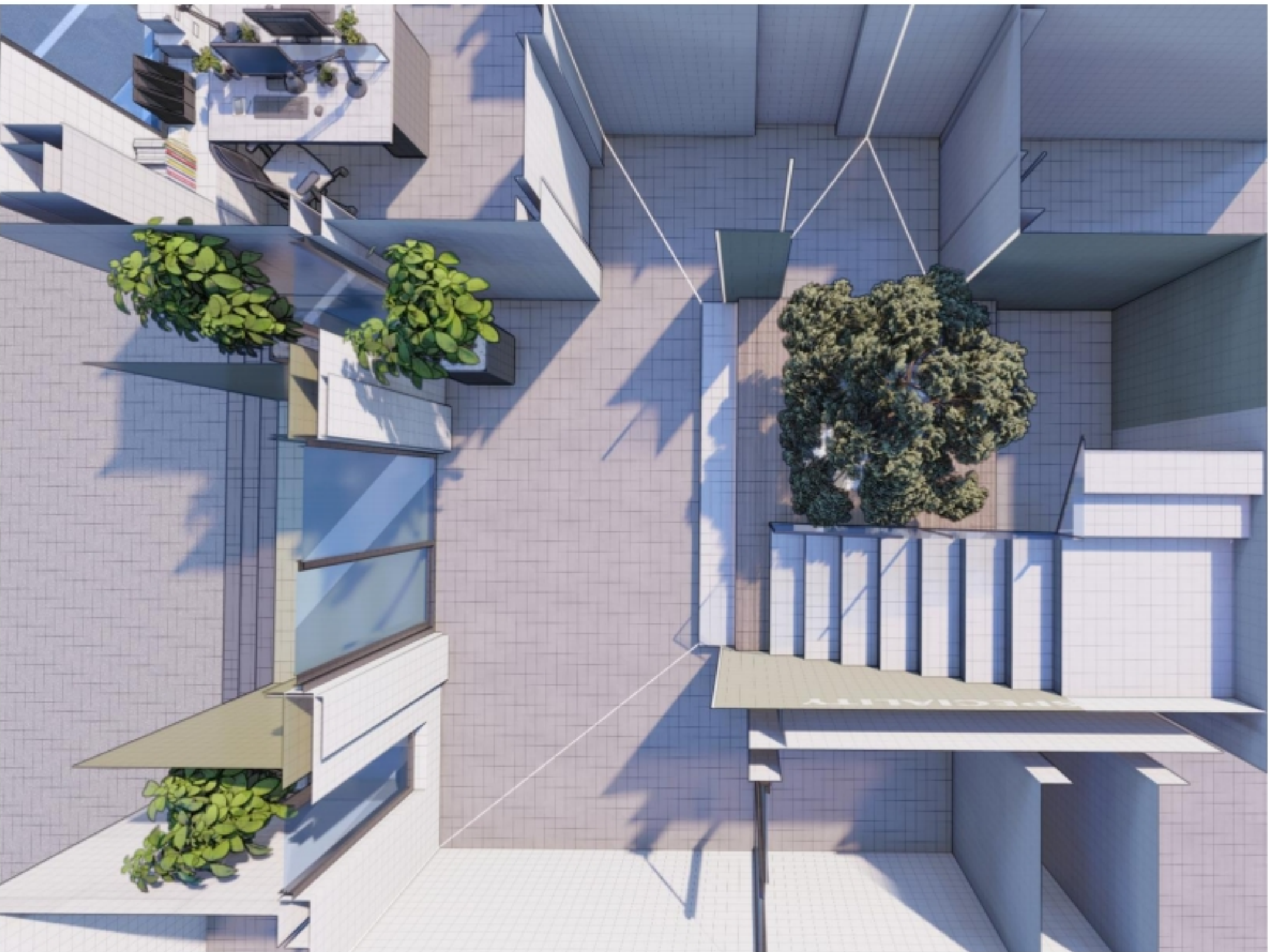

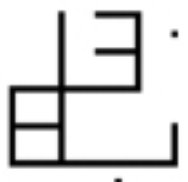

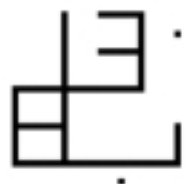

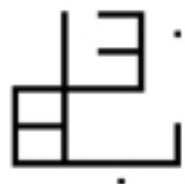

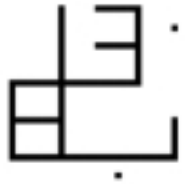

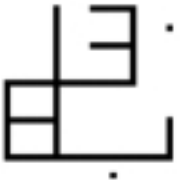

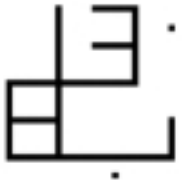

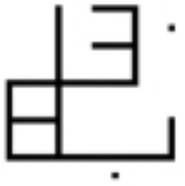

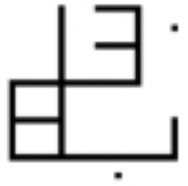

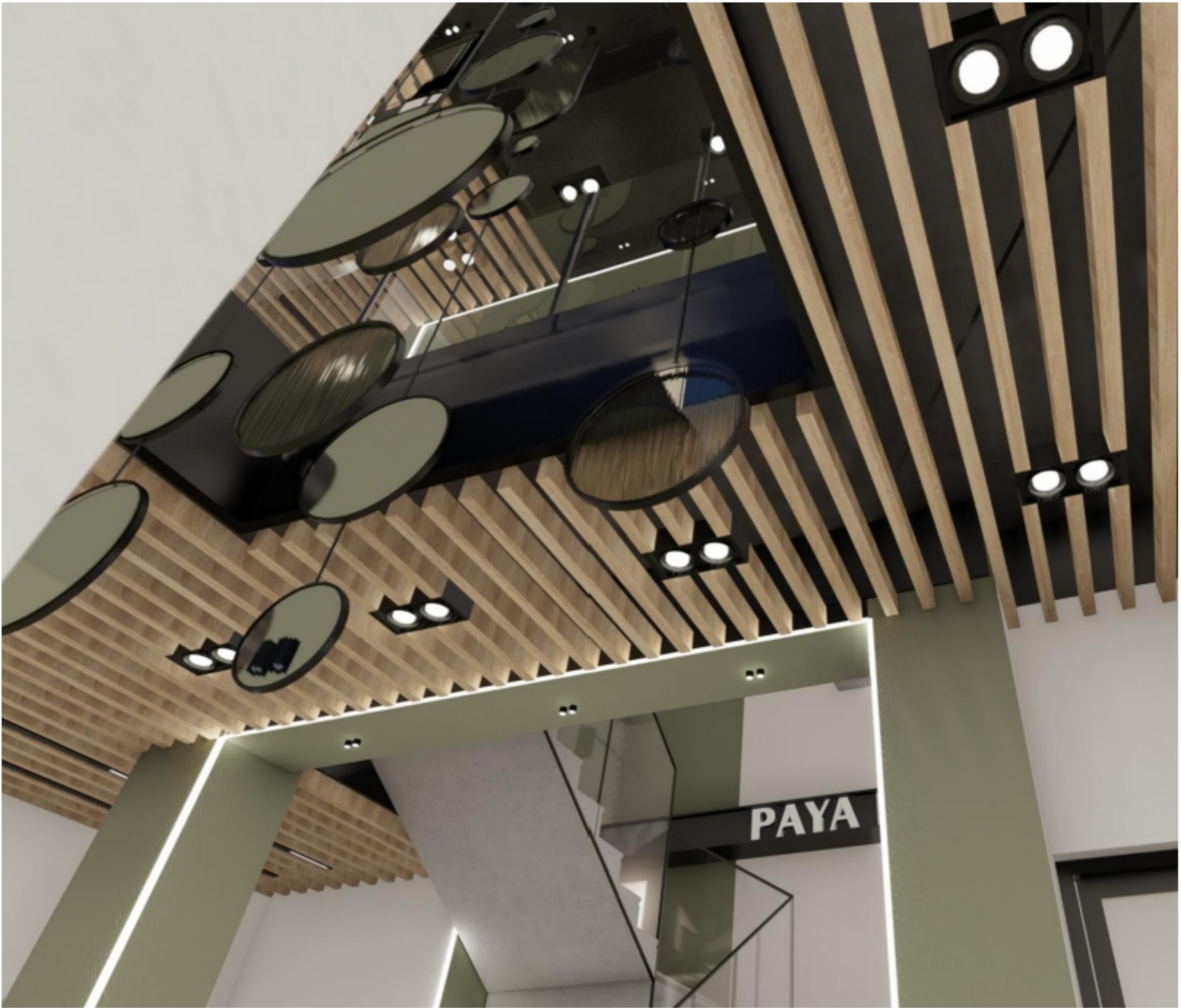
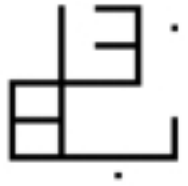

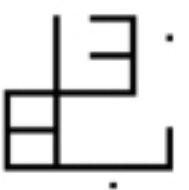
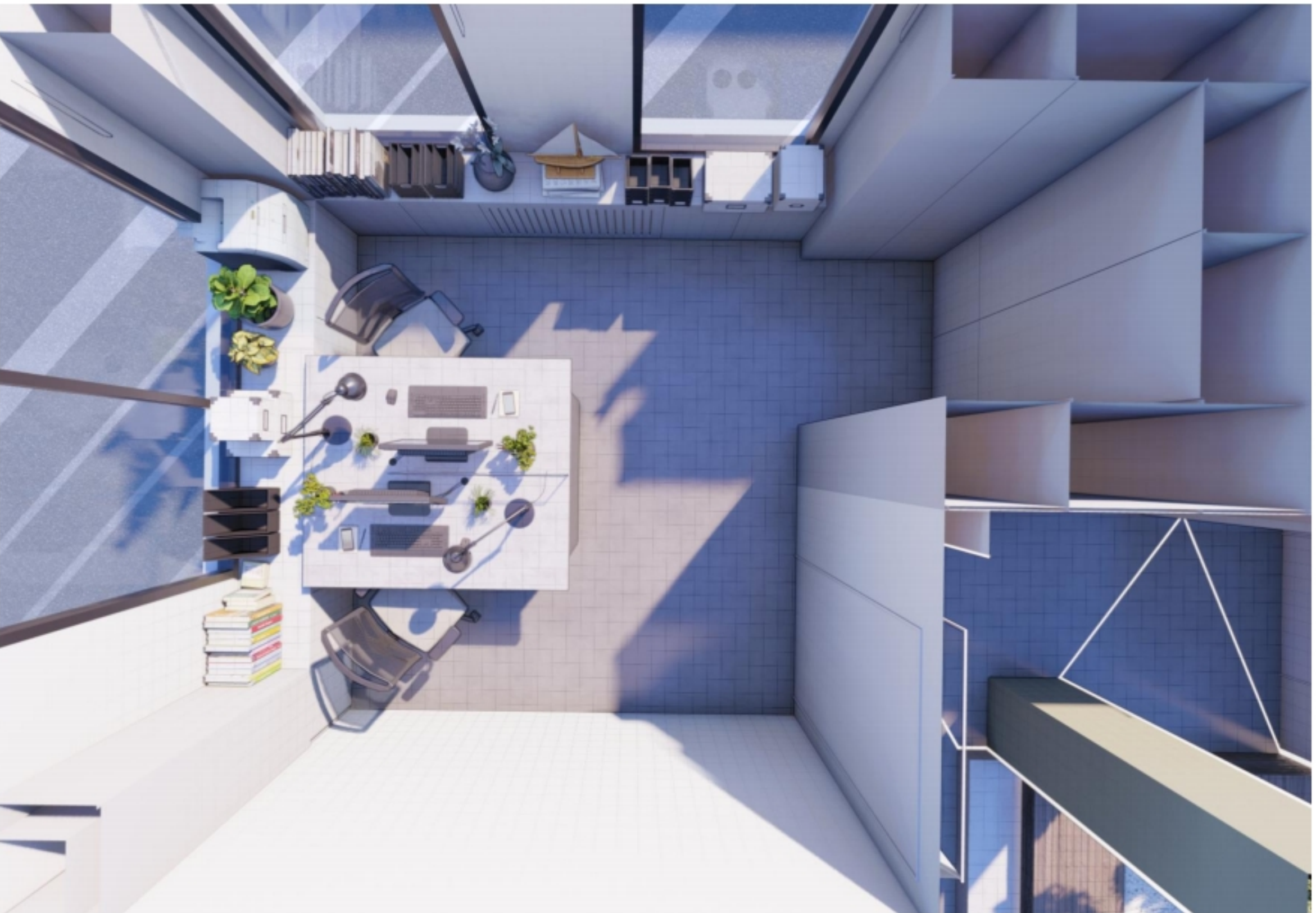

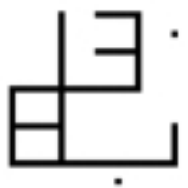

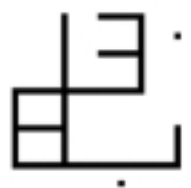

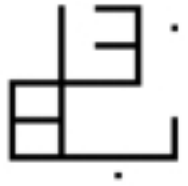

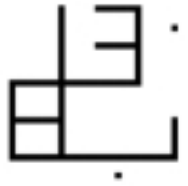

INTERIOR DESIGN/ FIRST FLOOR

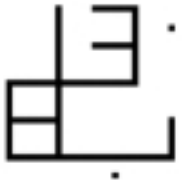
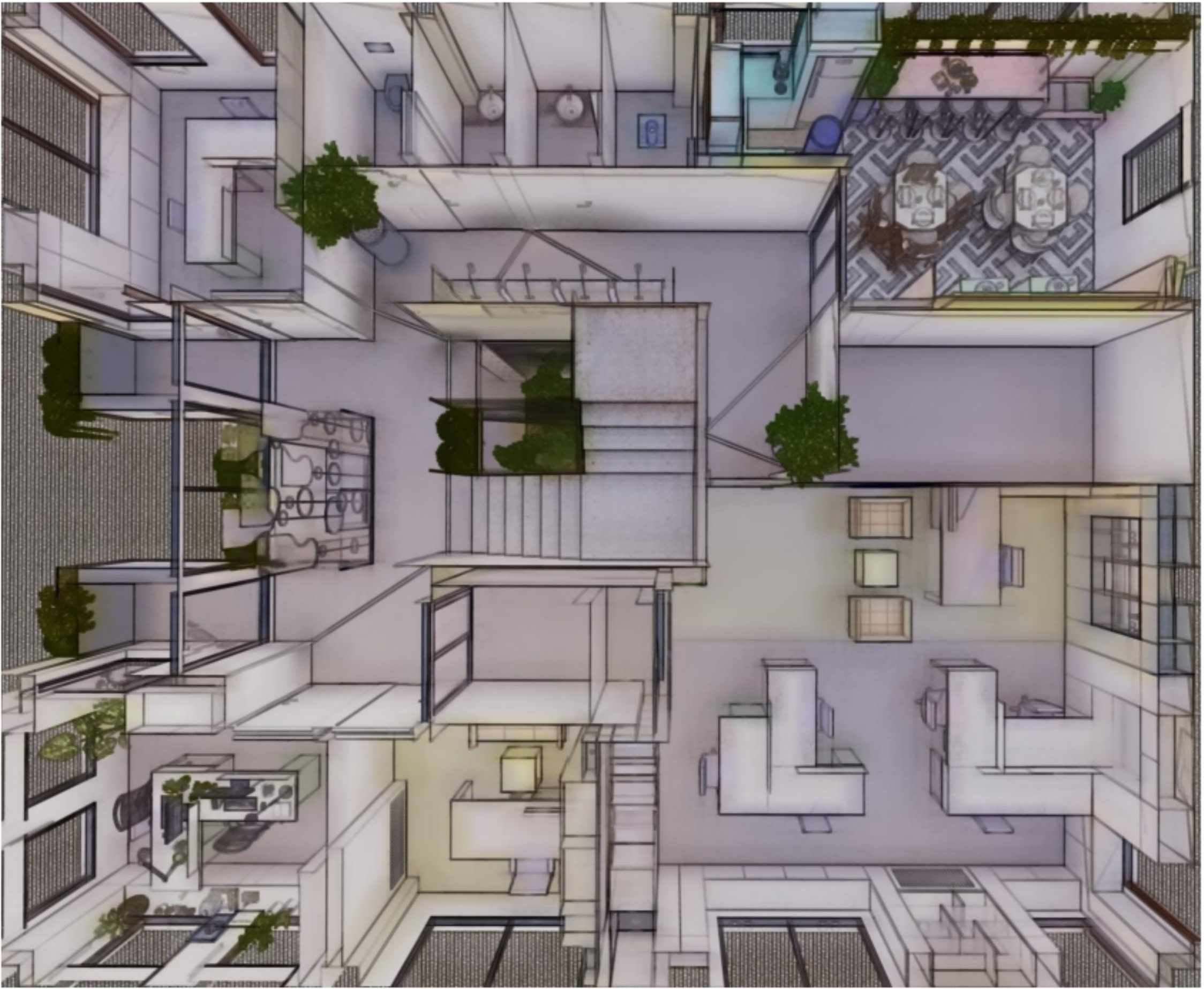

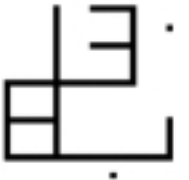
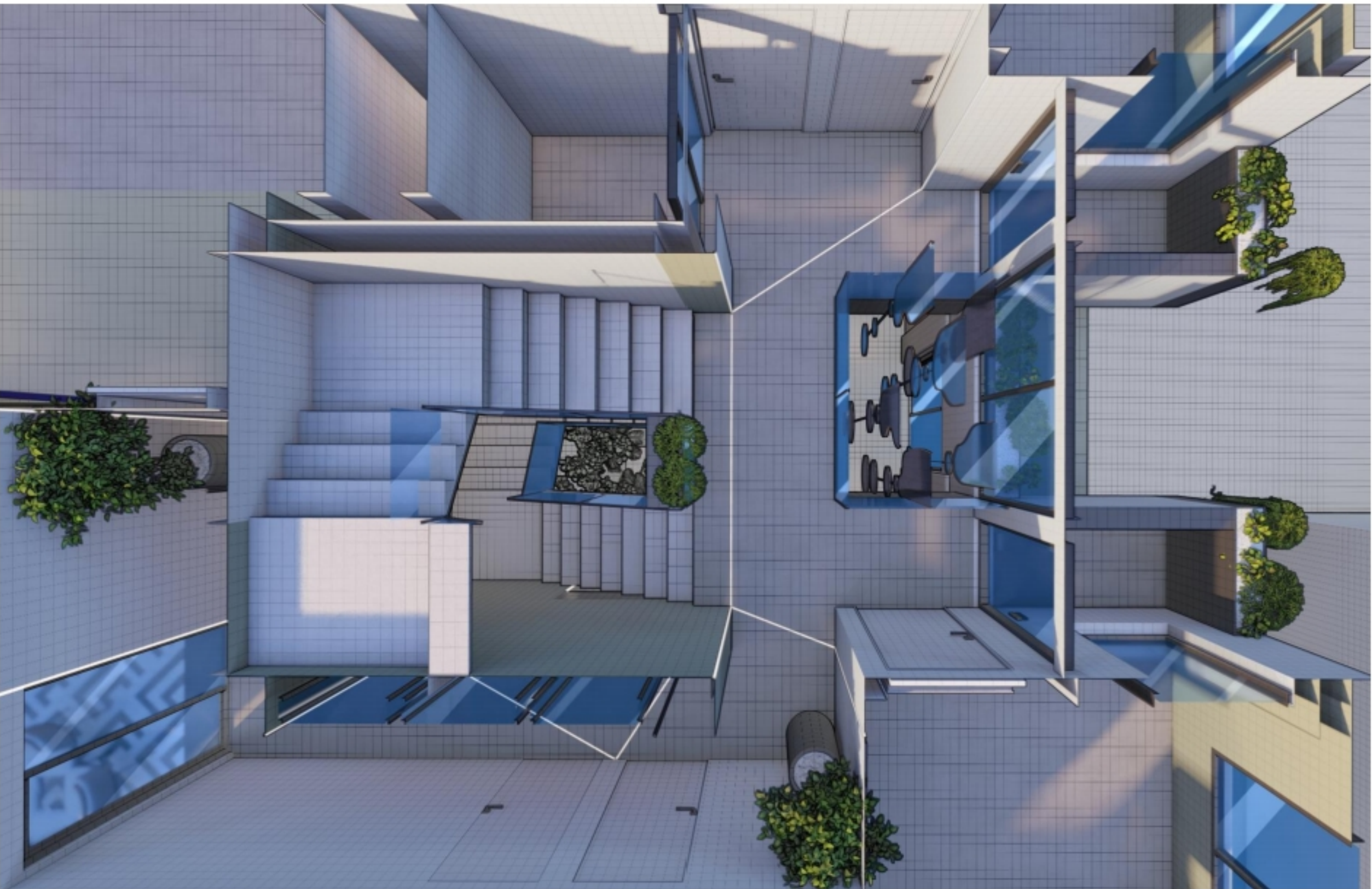

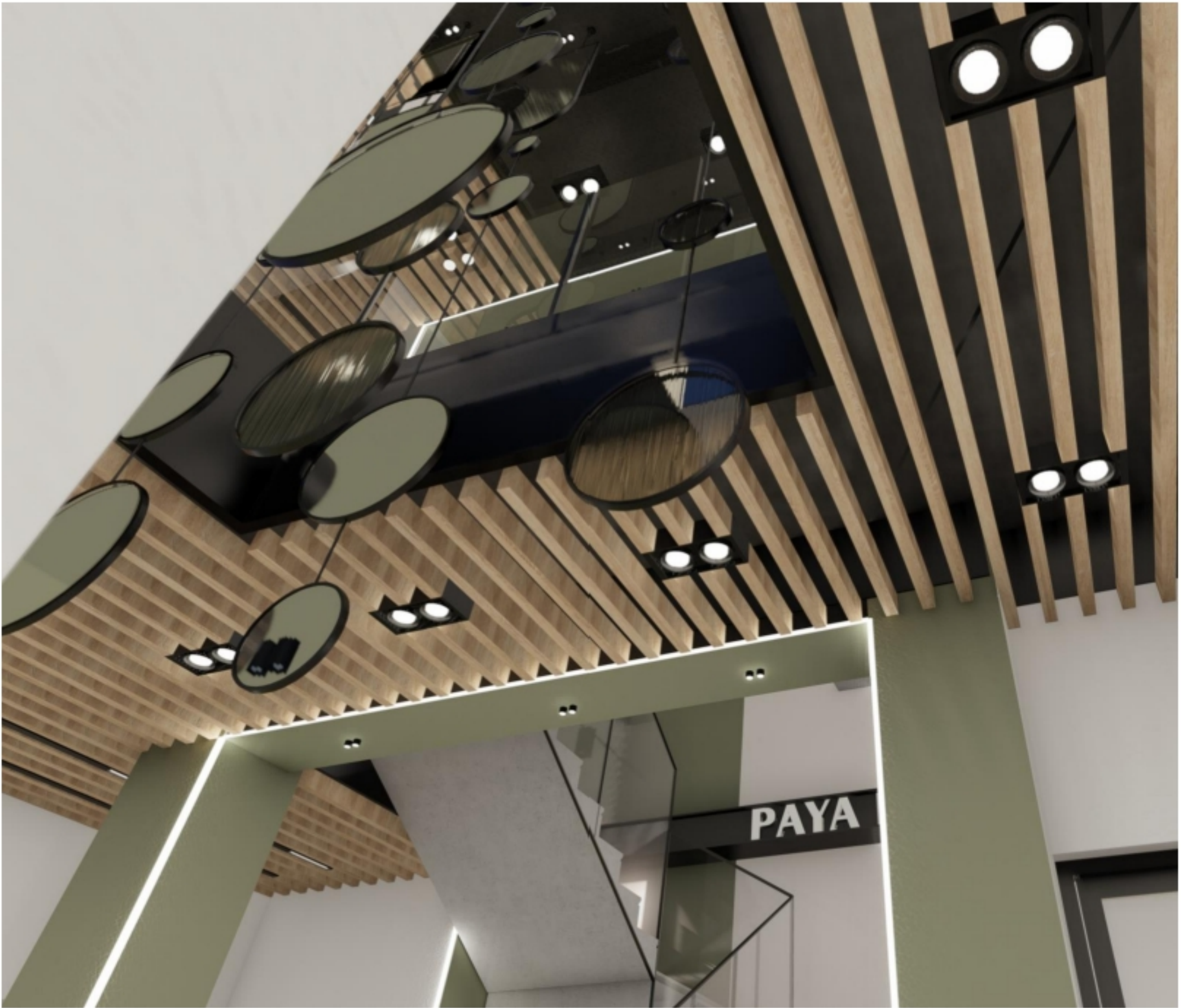
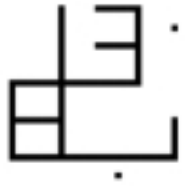

PAYYA LUB

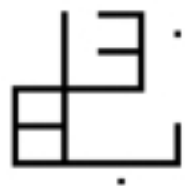

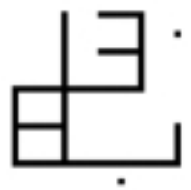

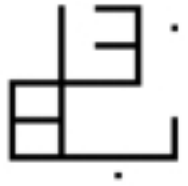

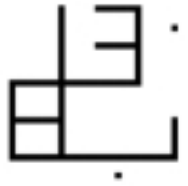

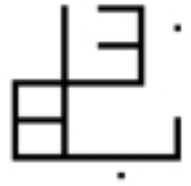

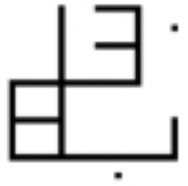

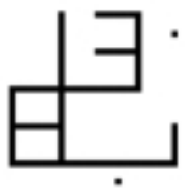

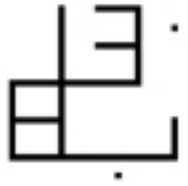

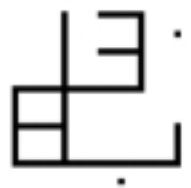

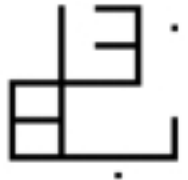

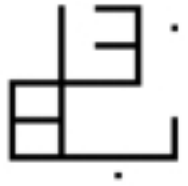

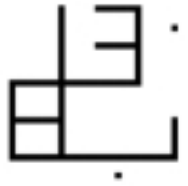

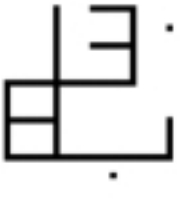

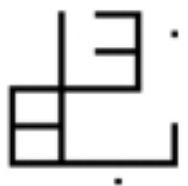

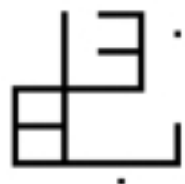

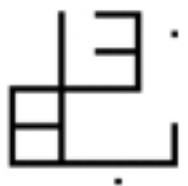

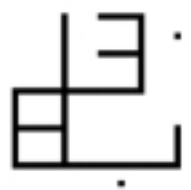

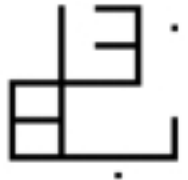

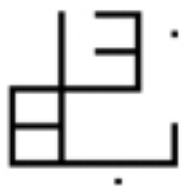

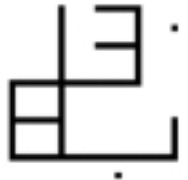

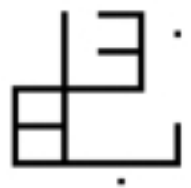

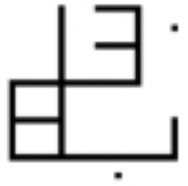

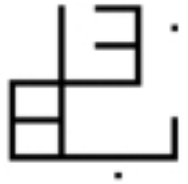

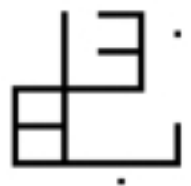

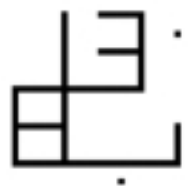

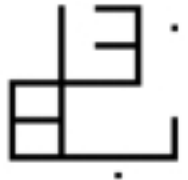

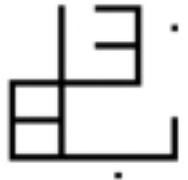

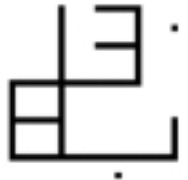

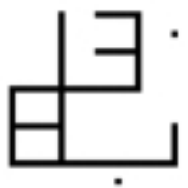

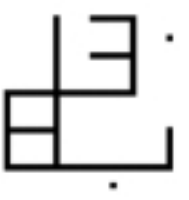
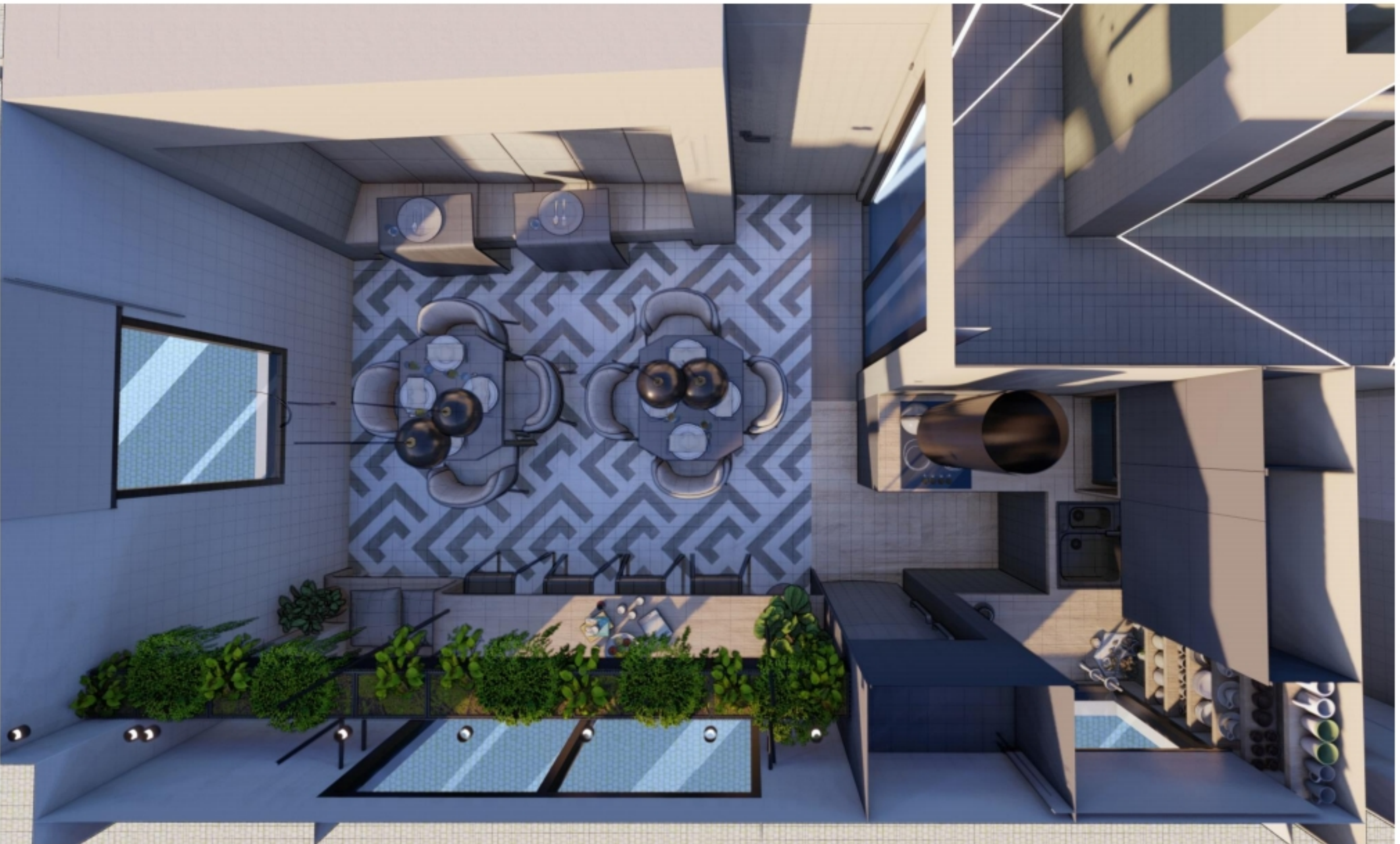

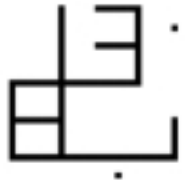

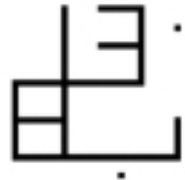

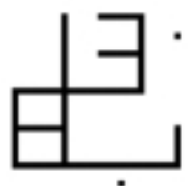

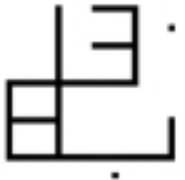

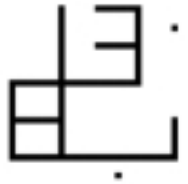

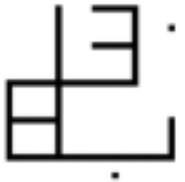

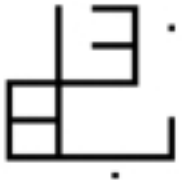

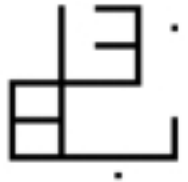

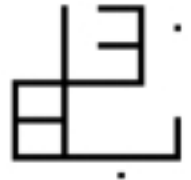

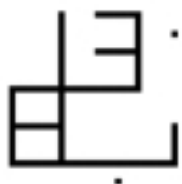

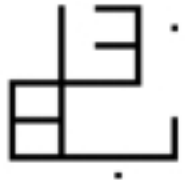

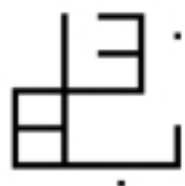

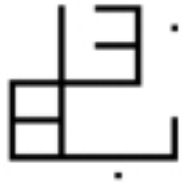

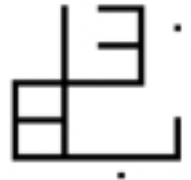

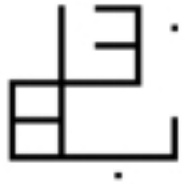

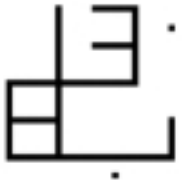

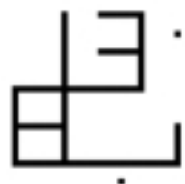

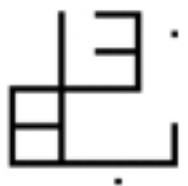

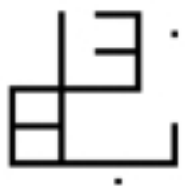

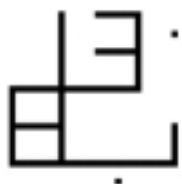

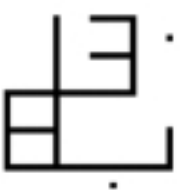
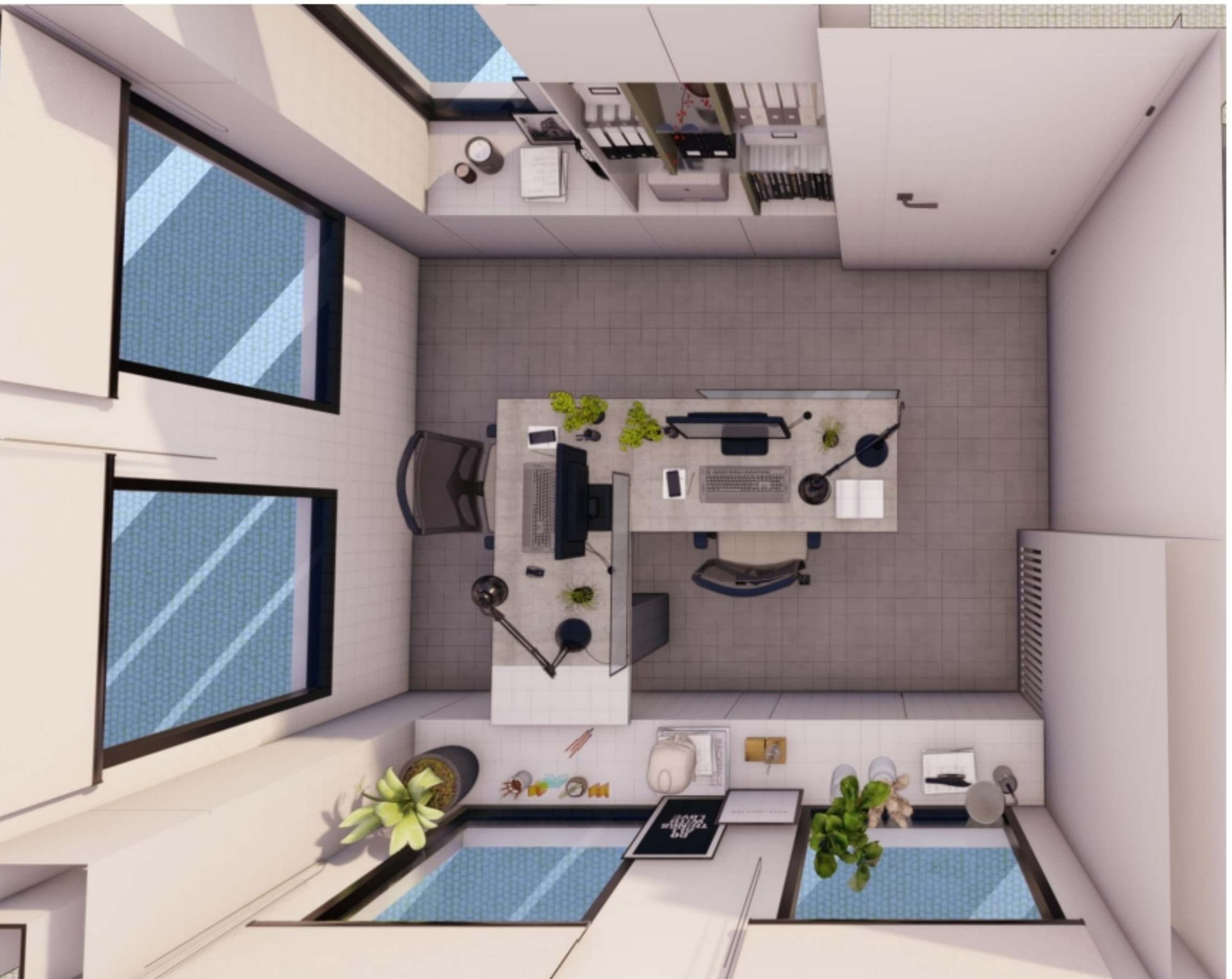

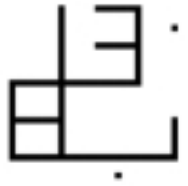

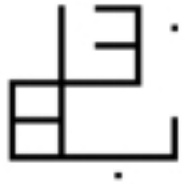

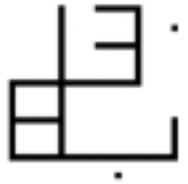

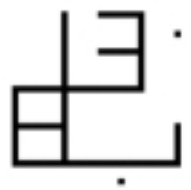

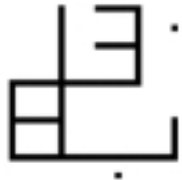

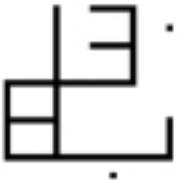

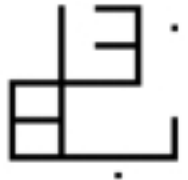

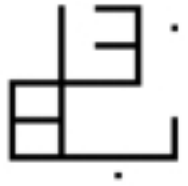

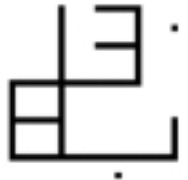

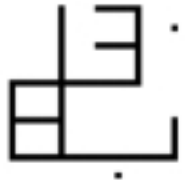

INTERIOR DESIGN/ SECOND FLOOR

SECOND FLOOR/ CORRIDOR

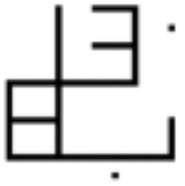

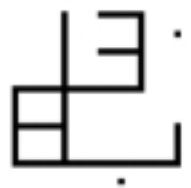

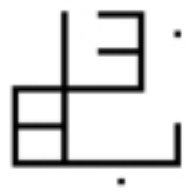

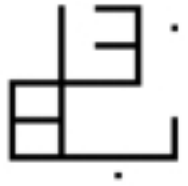

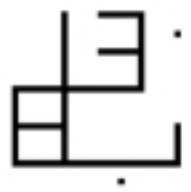

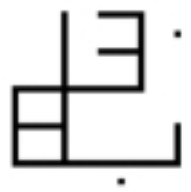

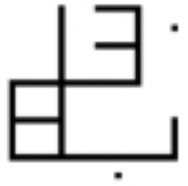

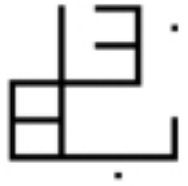

SECOND FLOOR/ SECRETARY'S ROOM

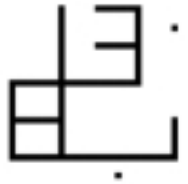

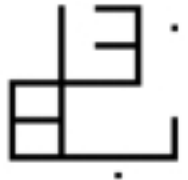

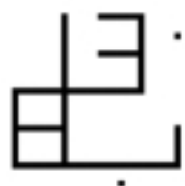

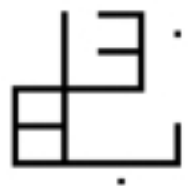

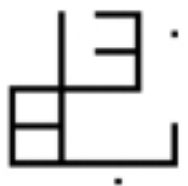

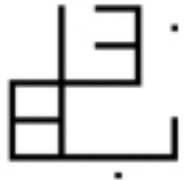

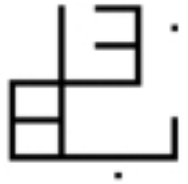

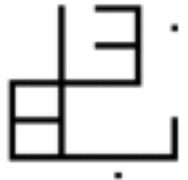

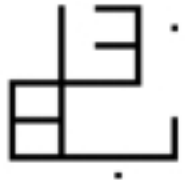

SECOND FLOOR/ CEO's Office

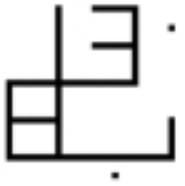

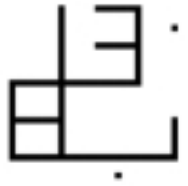

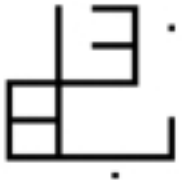

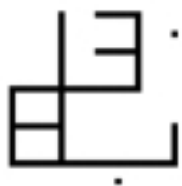

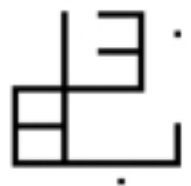

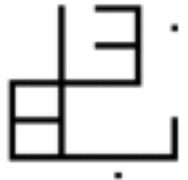

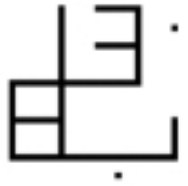

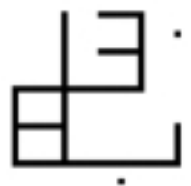

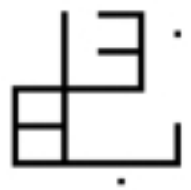

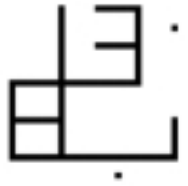

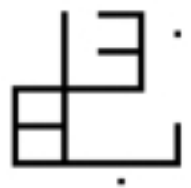

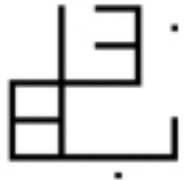

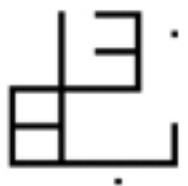

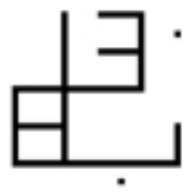

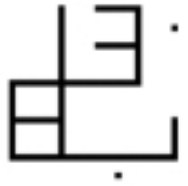

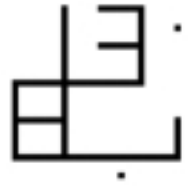

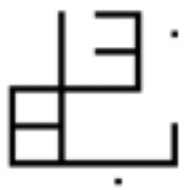
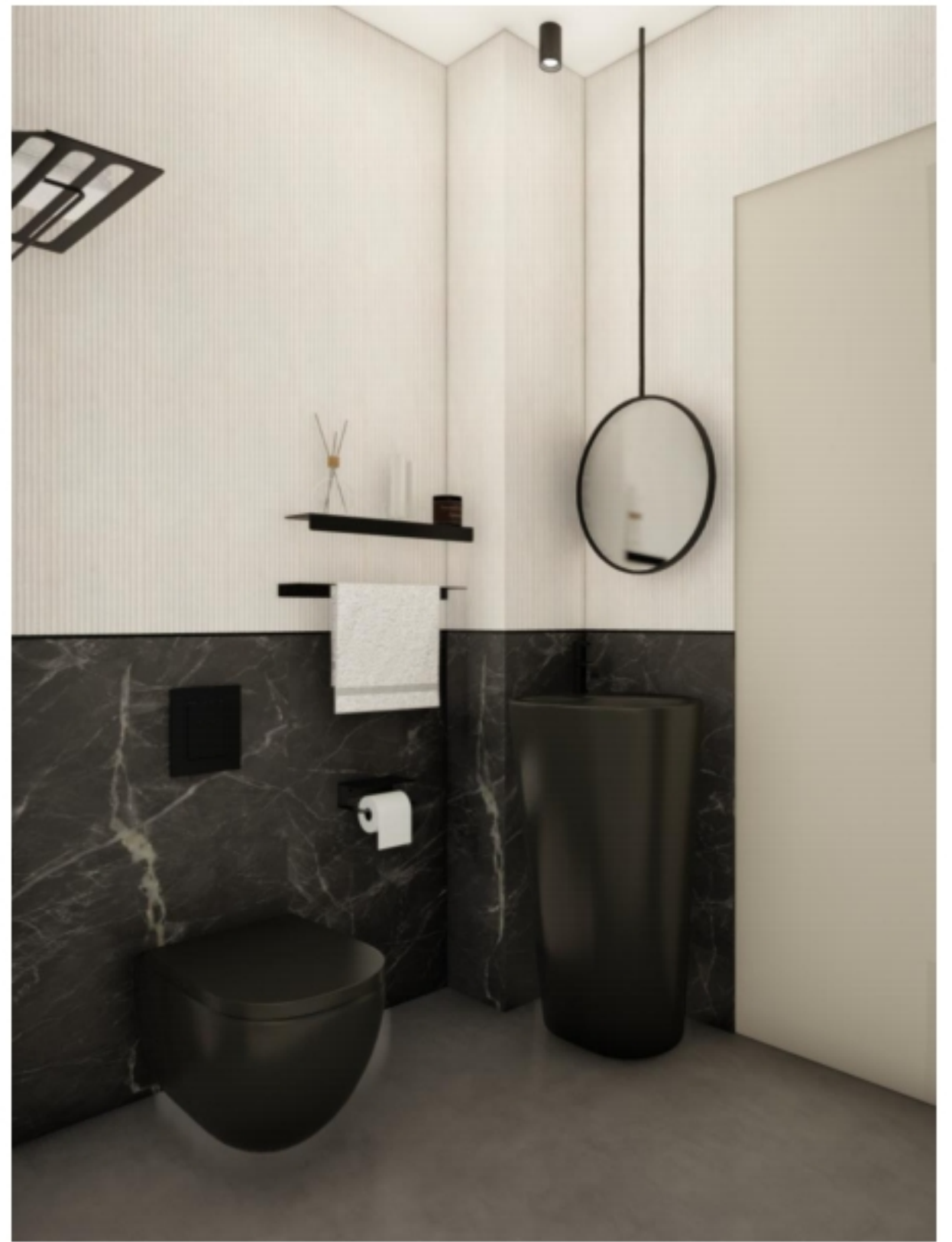
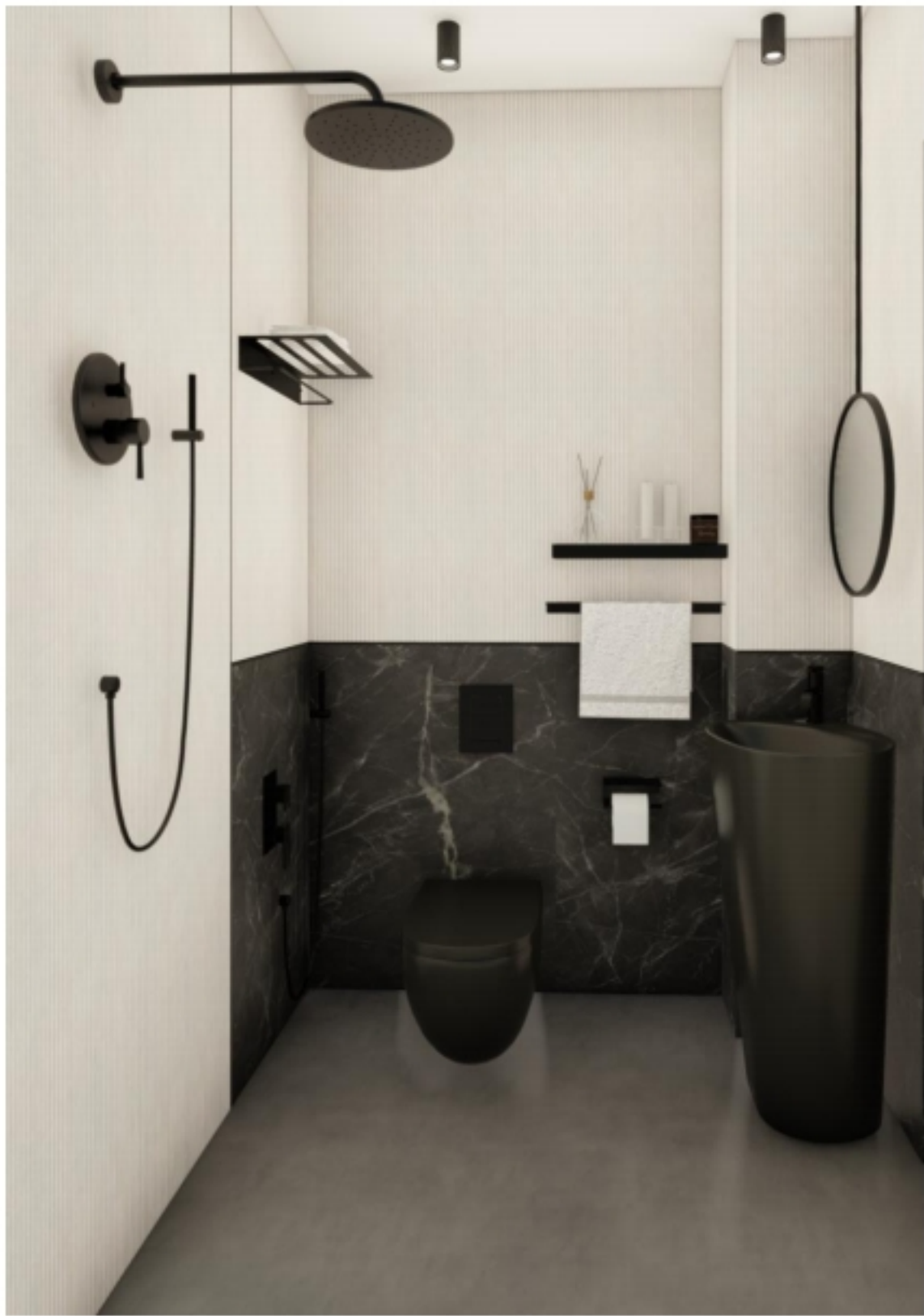

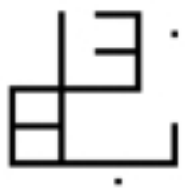

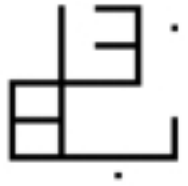

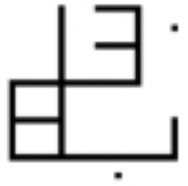

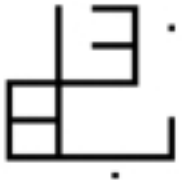

SECOND FLOOR/ CONFERENCE ROOM

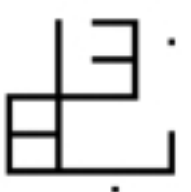

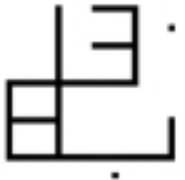

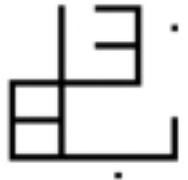

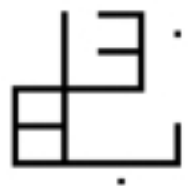

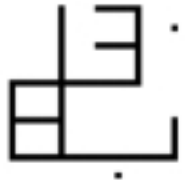

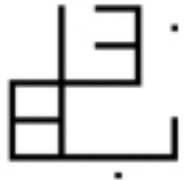

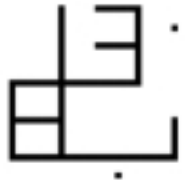

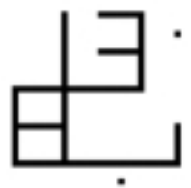

SECOND FLOOR/ MANAGER'S Office

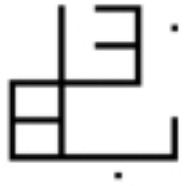

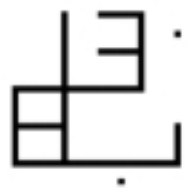

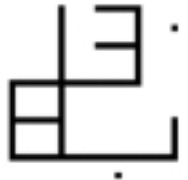

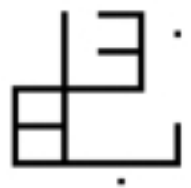

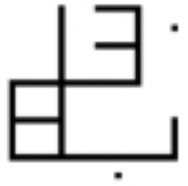

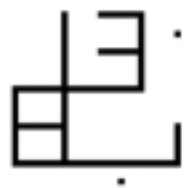

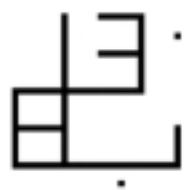



SECOND FLOOR/ KITCHEN

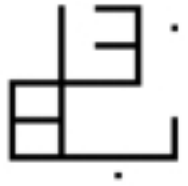

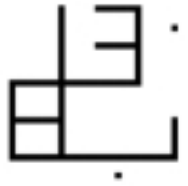

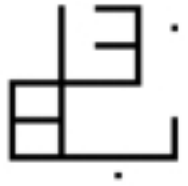

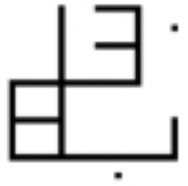

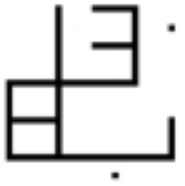

BATH ROOM

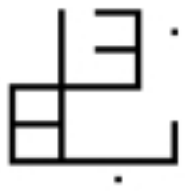

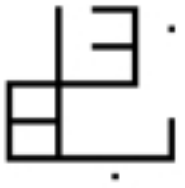

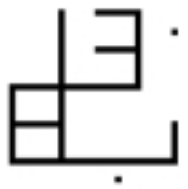

PLANS

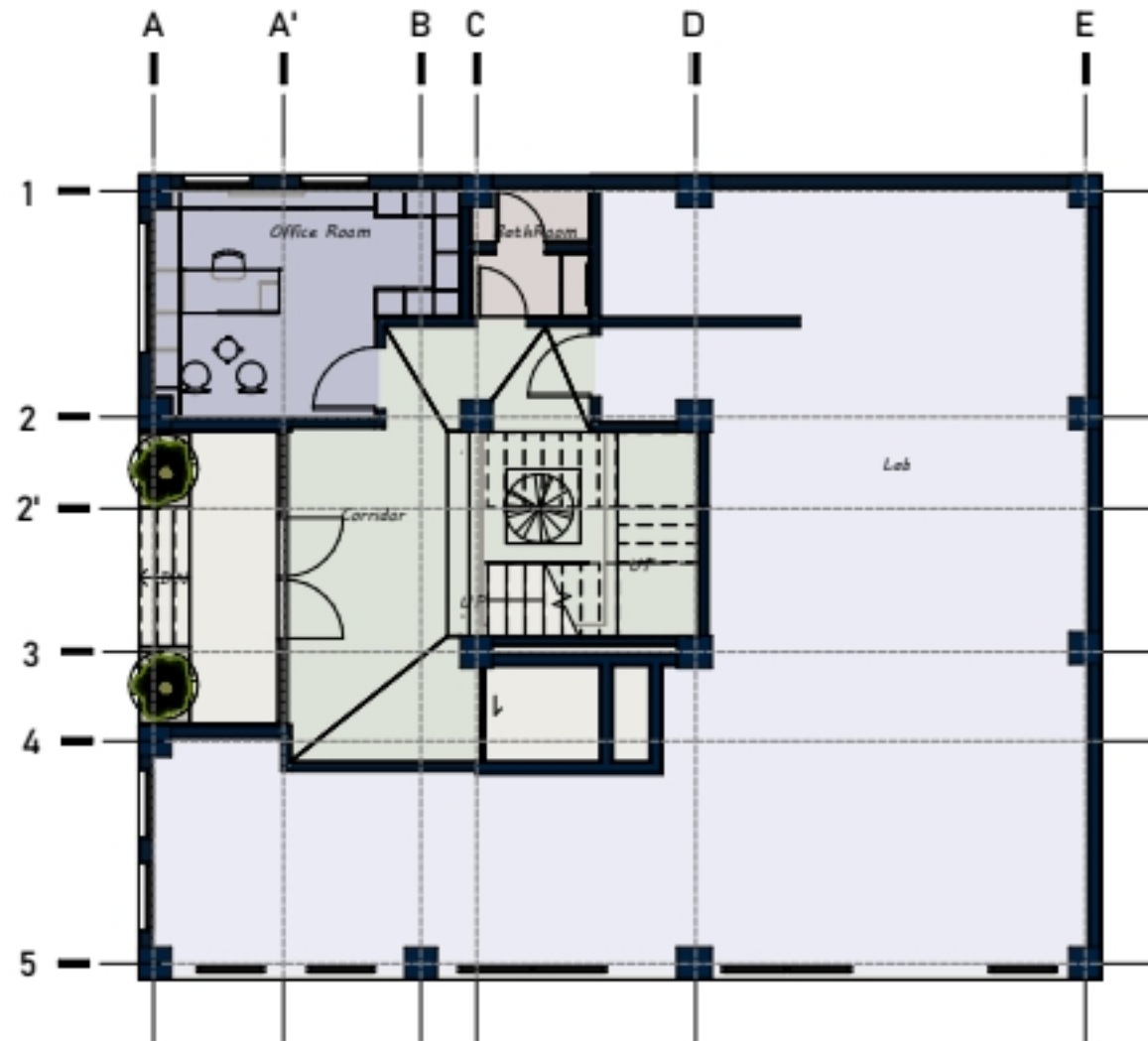

OFFICE Legend

- Office Room
- Corridor
- Lab
- BathRoom

1.1-GROUND FLOOR_FURNITURE PLAN

1 : 100

PROJECT NAME : PAYARAVANKARAN Office

CLIENT : **PAYA RAVANKARAN ALBORZ**

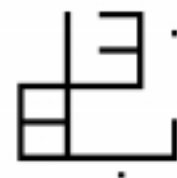

ARCHITECT : MAHSA RAHMATI

ABSAB ARCHITECTURAL DESIGN & CONSTRUCTION TEAM

GROUND FLOOR_FURNITURE PLAN

Project number
Date Issue Date
Drawn by
Paper Size : A3

A101

Scale

No.	Description	Date



OFFICE Legend

- Management Room
- Office Room
- Server Room
- Corridor
- Kitchen
- Dining Room
- BathRoom
- Stair
- Elevator
- Terrace

1. 1ST FLOOR_FURNITURE PLAN
 1 : 100

PROJECT NAME : PAYARAVANKARAN Office
 CLIENT : **PAYA RAVANKARAN ALBORZ**

ARCHITECT : MAHSA RAHMATI
ABSAB ARCHITECTURAL DESIGN & CONSTRUCTION TEAM

FIRST FLOOR_FURNITURE PLAN
 Project number :
 Date : Issue Date :
 Drawn by :
 Paper Size : A3 Scale : **A102**

No.	Description	Date



- OFFICE Legend**
- Management Room
 - Conferance Room
 - Corridor
 - Kitchen
 - Management Office
 - Manager's Suite
 - BathRoom
 - Room
 - Elevator
 - Terrace

1 - 2nd Floor_FURNITURE PLAN
 1 : 100

PROJECT NAME : **PAYARAVANKARAN Office**
 CLIENT : **PAYA RAVANKARAN ALBORZ**

ARCHITECT : **MAHSA RAHMATI**
ABSAB ARCHITECTURAL DESIGN & CONSTRUCTION TEAM

SECOND FLOOR_FURNITURE PLAN
 Project number _____
 Date _____ Issue Date _____
 Drawn by _____
 Paper Size : A3 Scale _____

No.	Description	Date

PWA 001-81-5-20050700

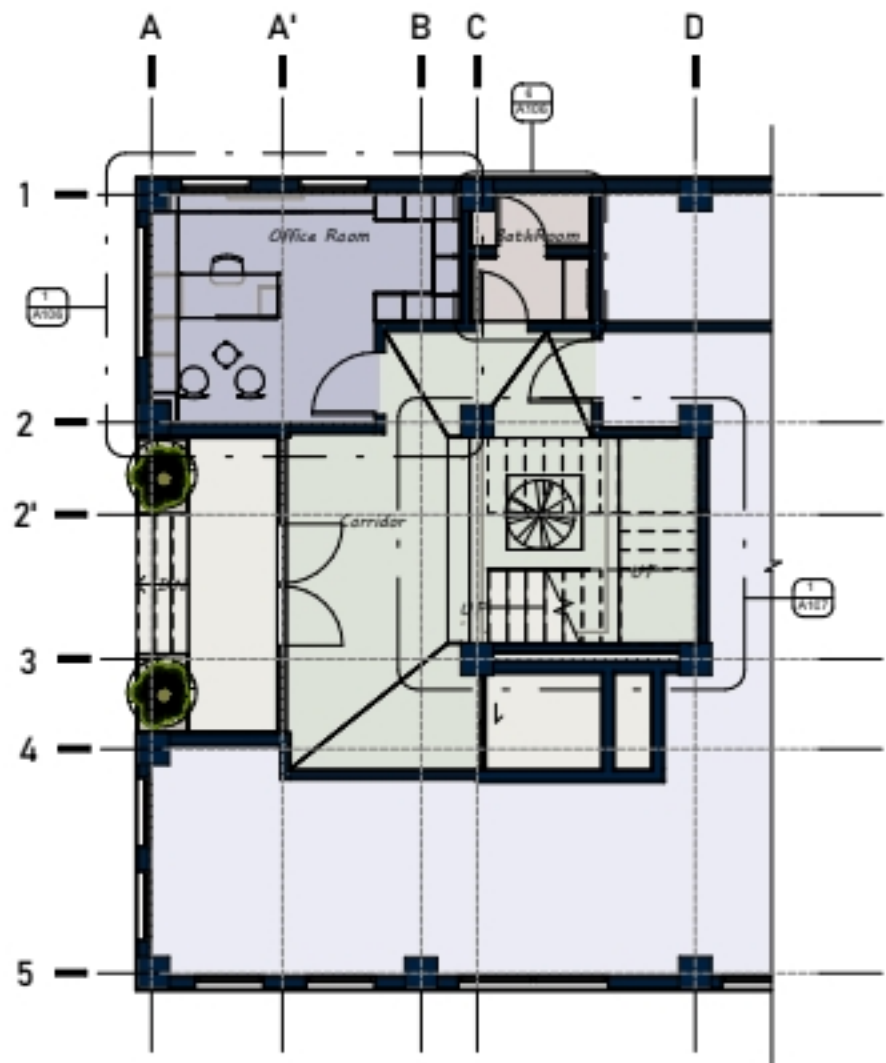

1. G.F-LAYOUT HOT KEY PLAN

1 : 100

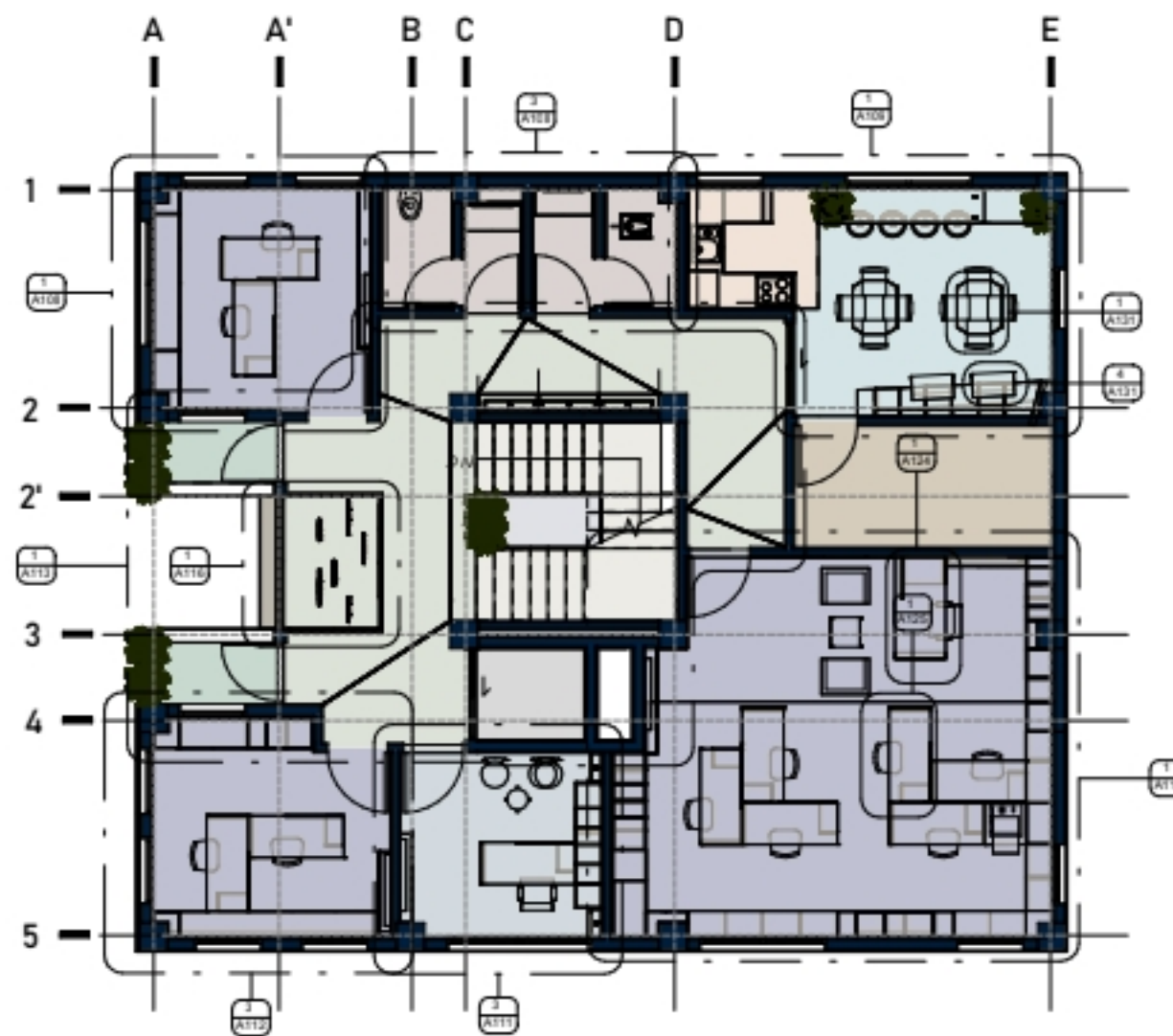

2. 1st Floor- LAYOUT HOT KEY PLAN

1 : 100

PROJECT NAME : PAYARAVANKARAN Office

CLIENT : **PAYA RAVANKARAN ALBORZ**

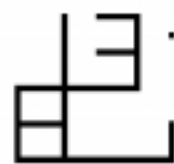

ARCHITECT : MAHSA RAHMATI

ABSAB ARCHITECTURAL DESIGN & CONSTRUCTION TEAM

LAYOUT KEY PLAN(GF&1ST)

Project number

Date

Drawn by

Paper Size :

Issue Date

A104

Scale

No.	Description	Date

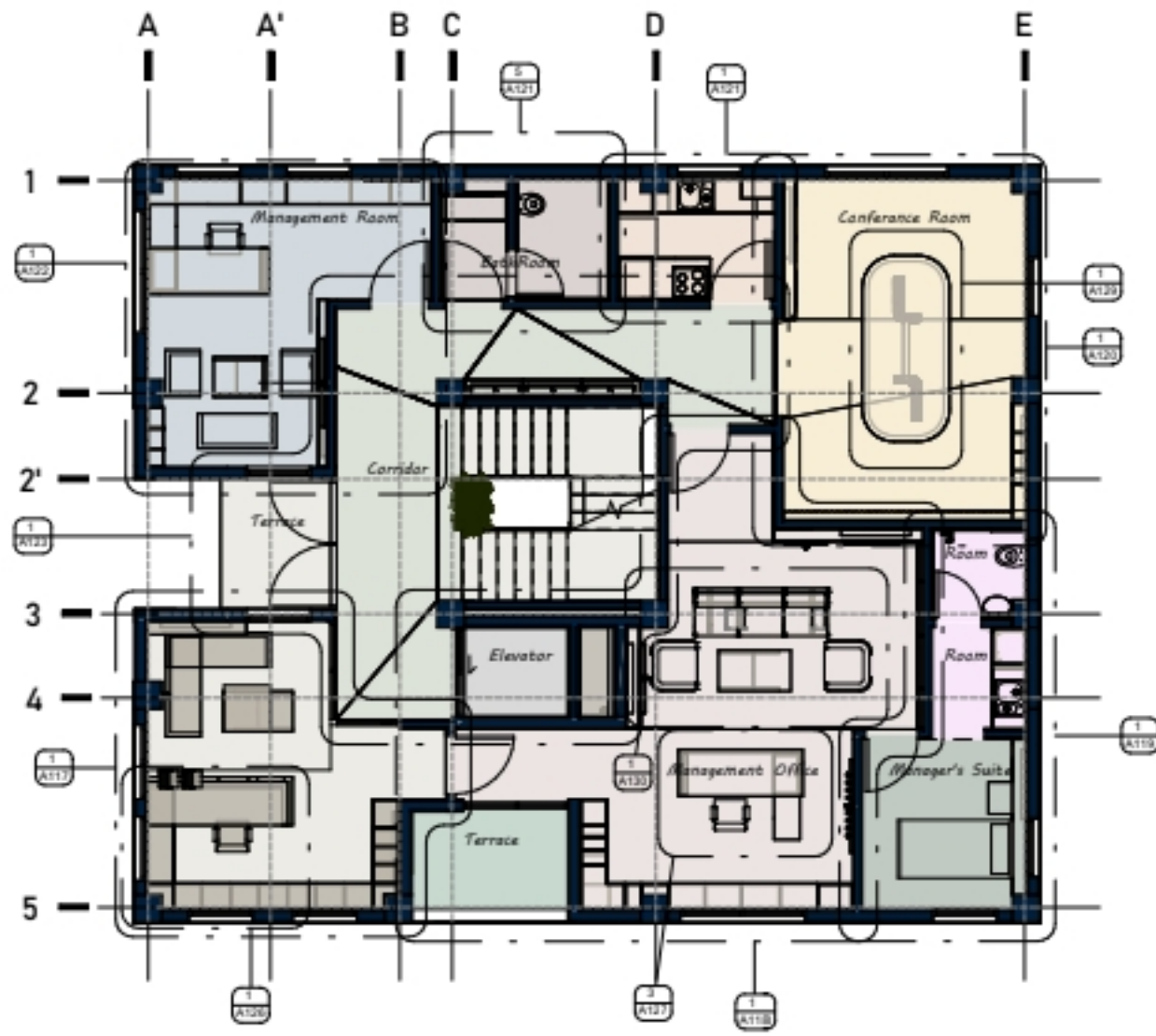

1. 2nd Floor- Layout Hot Key Plan

1 : 100

PROJECT NAME : PAYARAVANKARAN Office

CLIENT : **PAYA RAVANKARAN ALBORZ**

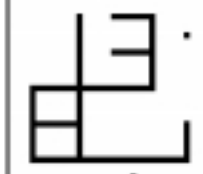

ARCHITECT : MAHSA RAHMATI

ABSAB ARCHITECTURAL DESIGN & CONSTRUCTION TEAM

LAYOUT KEY PLAN(2ND)

Project number
Date Issue Date
Drawn by
Paper Size : A3

A105
Scale

No.	Description	Date

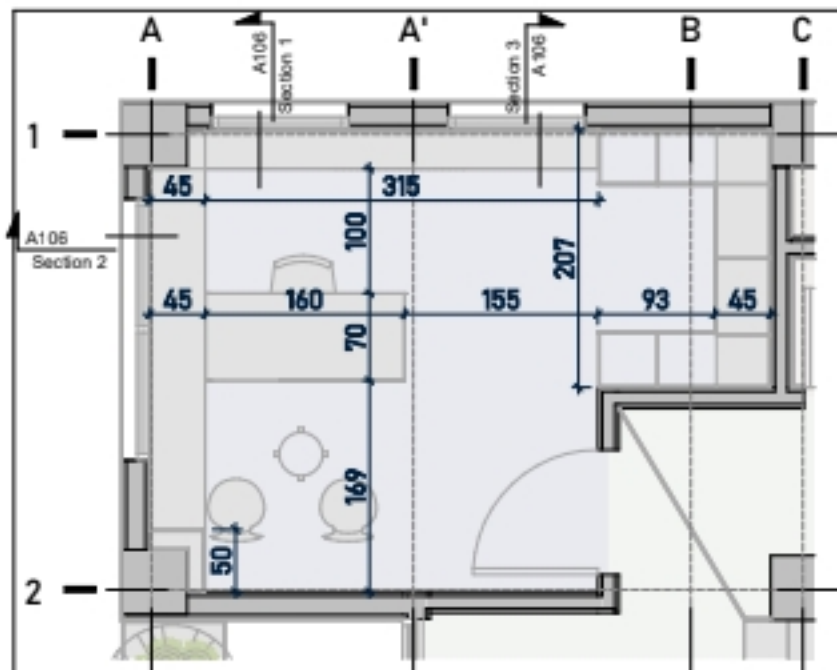

1. G.F - Layout 01

1 : 50

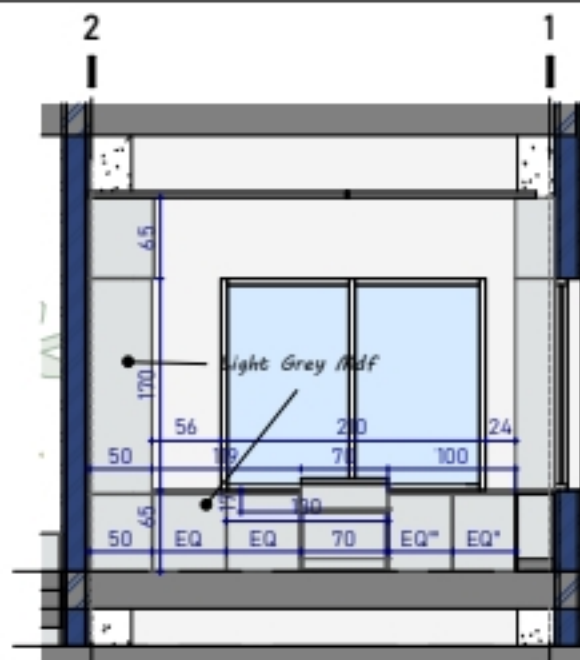

2. SECTION 1

1 : 50

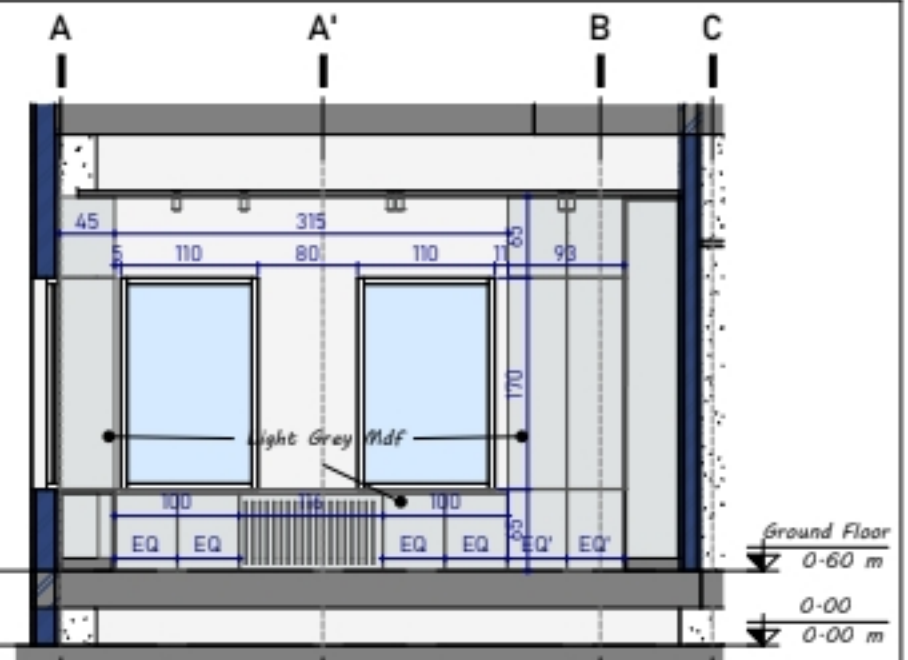

3. SECTION 2

1 : 50

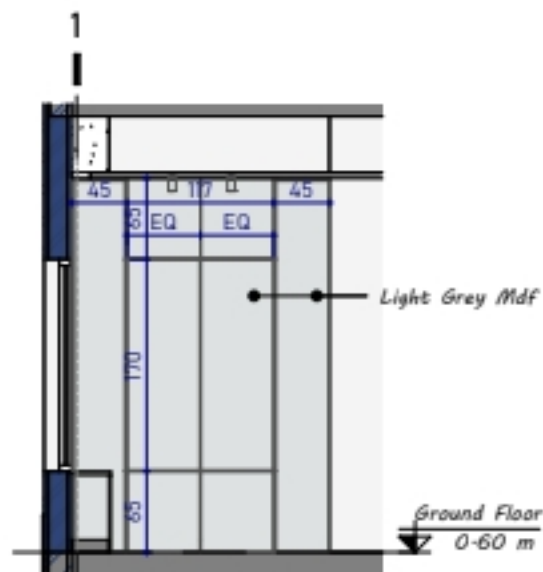

4. SECTION 3

1 : 50

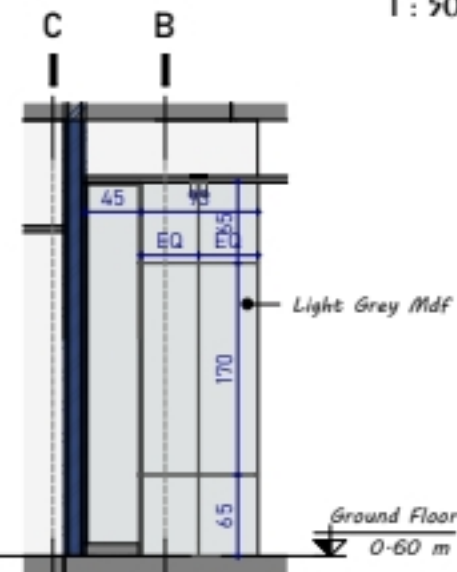

5. SECTION 4

1 : 50

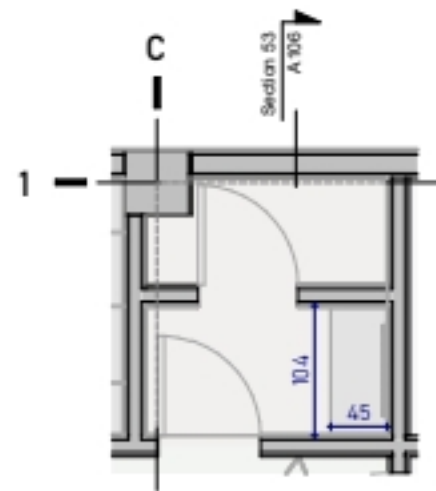

6. Gf-LAYOUT BATHROOM

1 : 50

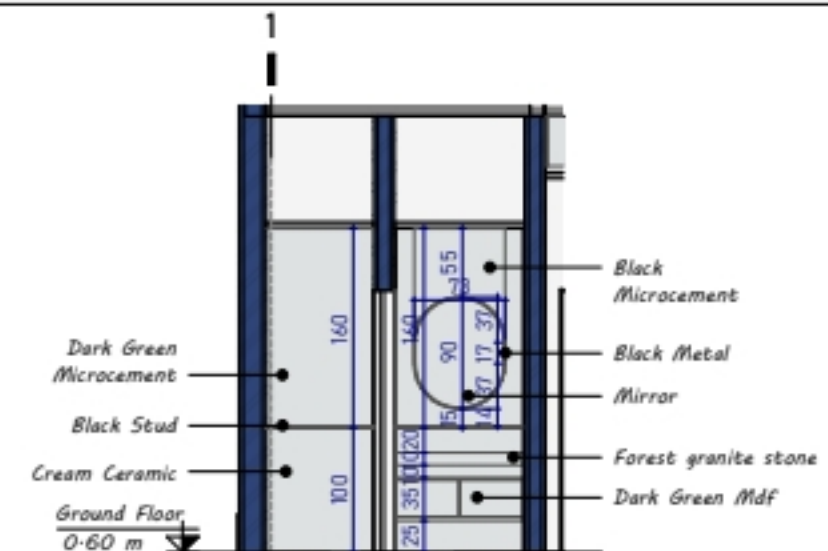

7. SECTION 53

1 : 50

PROJECT NAME : PAYARAVANKARAN Office

CLIENT : **PAYA RAVANKARAN ALBORZ**

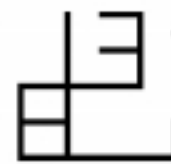

ARCHITECT : MAHSA RAHMATI

ABSAB ARCHITECTURAL DESIGN & CONSTRUCTION TEAM

GF-LAYOUT 01-Office Room 01

Project number	A106
Date	
Drawn by	
Paper Size :	A3
Scale	

No.	Description	Date

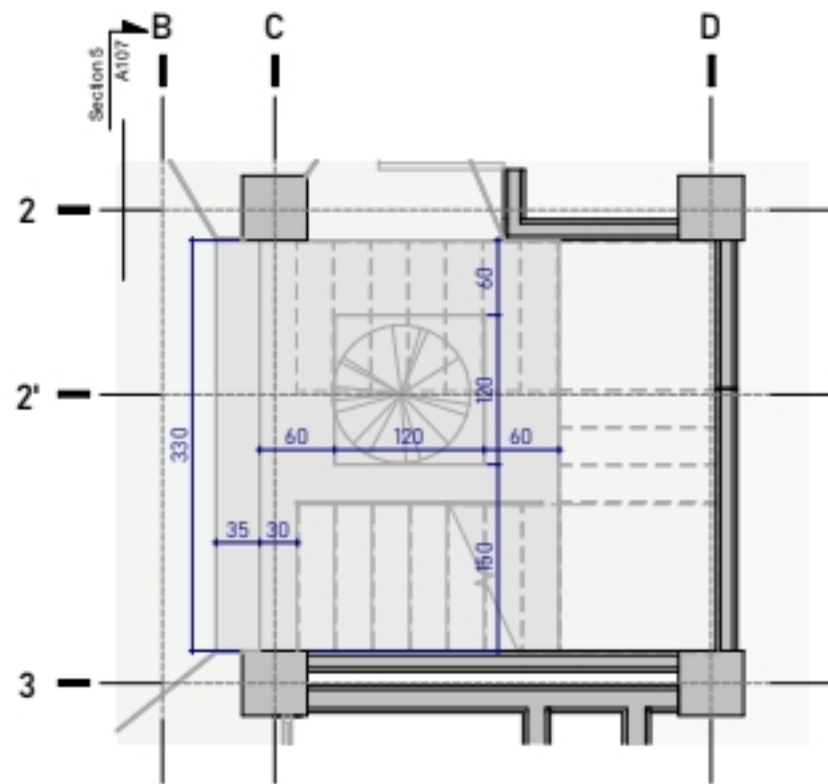

1. G.F - Layout 02

1 : 50

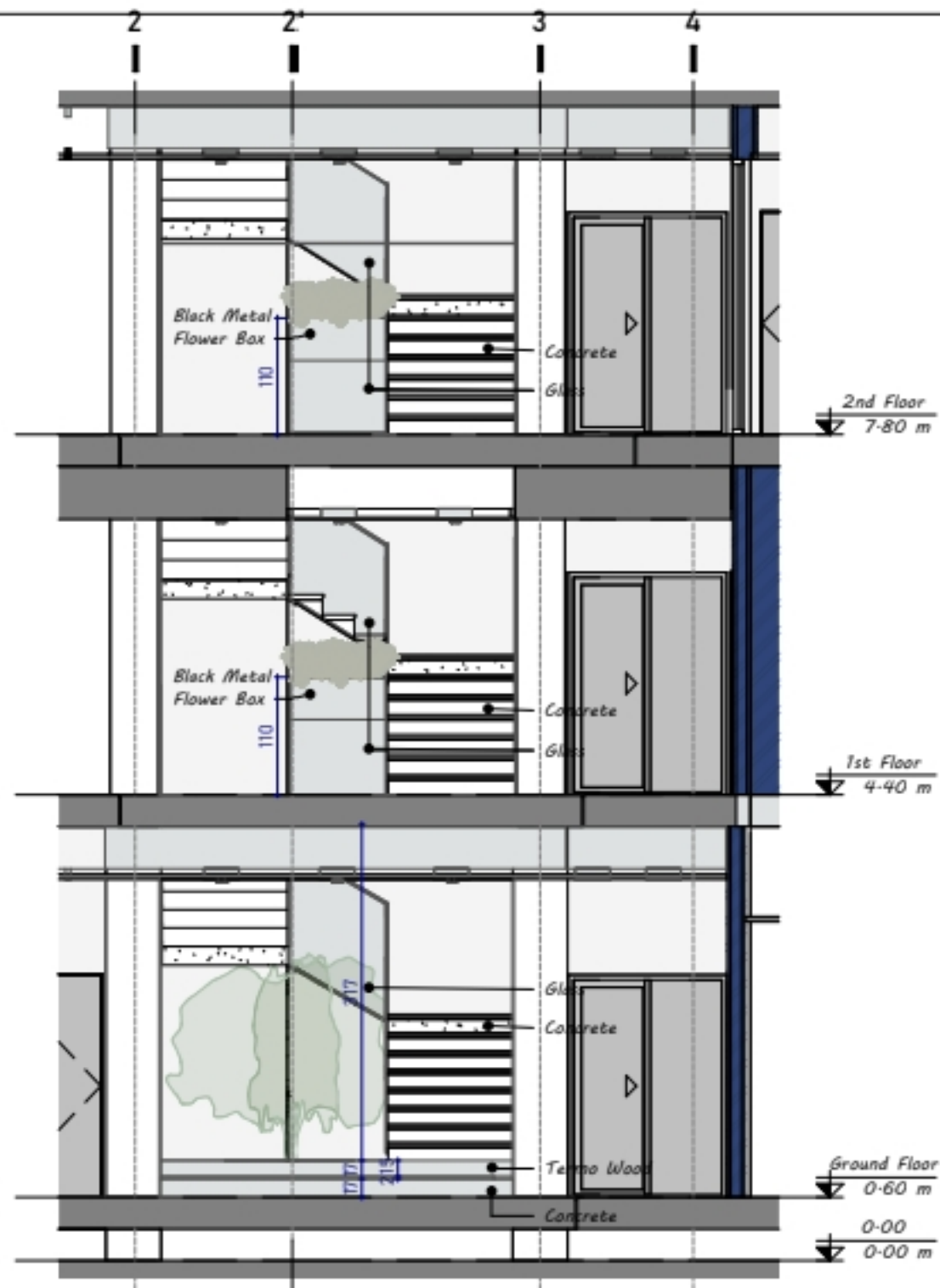

2. SECTION 5

1 : 50

PROJECT NAME : PAYARAVANKARAN Office

CLIENT : **PAYA RAVANKARAN ALBORZ**

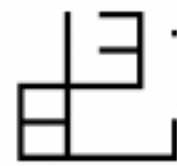

ARCHITECT : MAHSA RAHMATI

ABSAB ARCHITECTURAL DESIGN & CONSTRUCTION TEAM

GF-LAYOUT 02-STAIR

Project number
Date Issue Date
Drawn by
Paper Size : A3 Scale

A107

No.	Description	Date

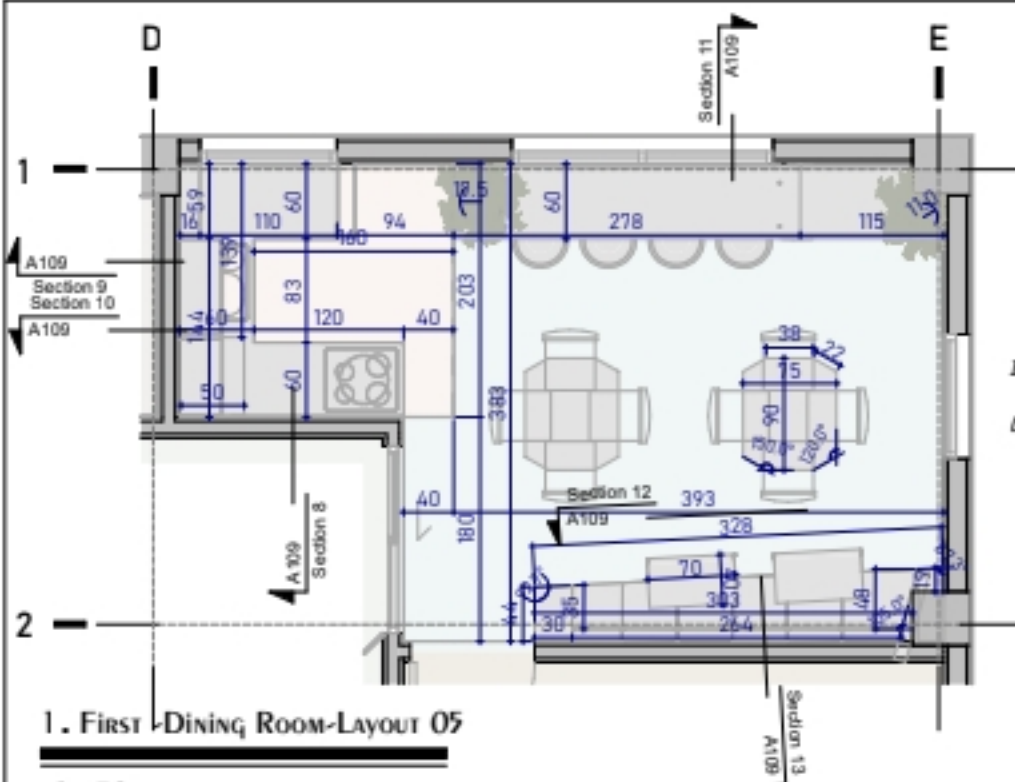

1. FIRST DINING ROOM-LAYOUT 05

1 : 50



2. SECTION 8

1 : 50

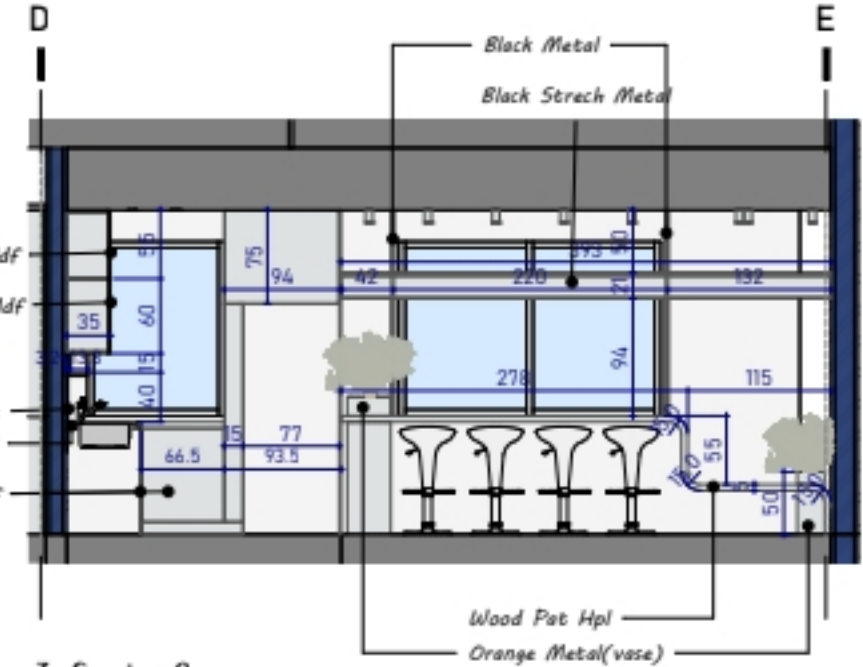

3. SECTION 9

1 : 50

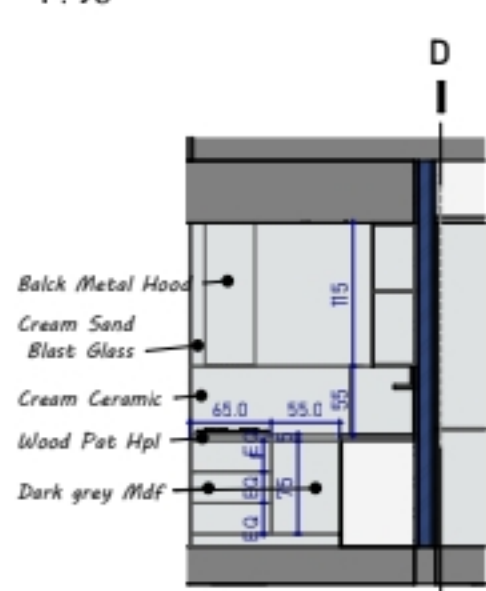

4. SECTION 10

1 : 50

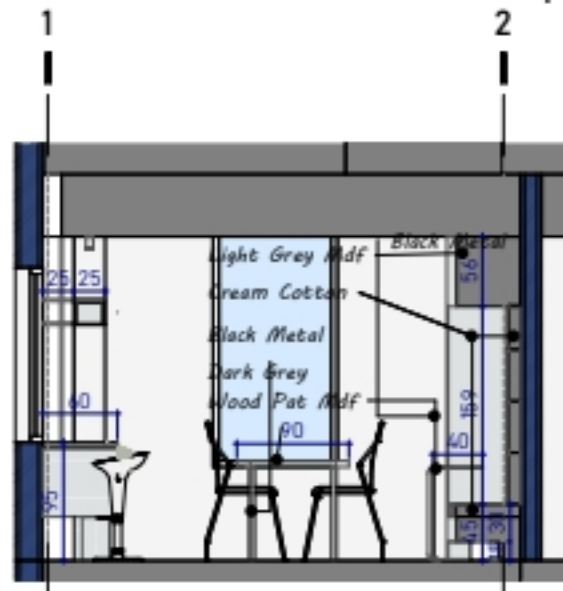

5. SECTION 11

1 : 50

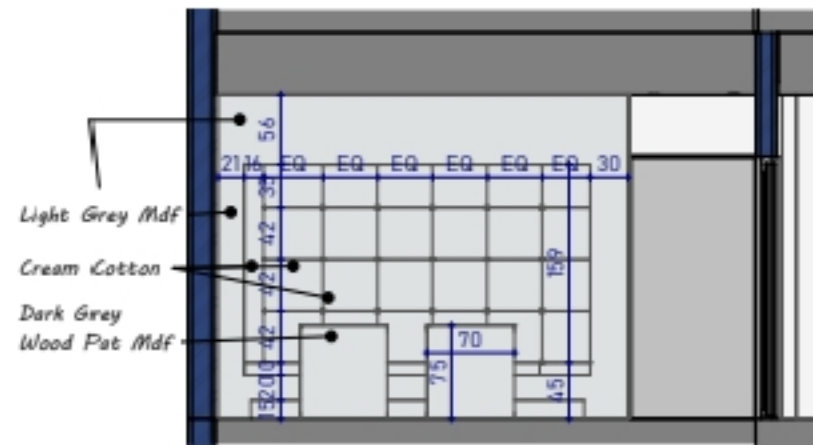

6. SECTION 12

1 : 50

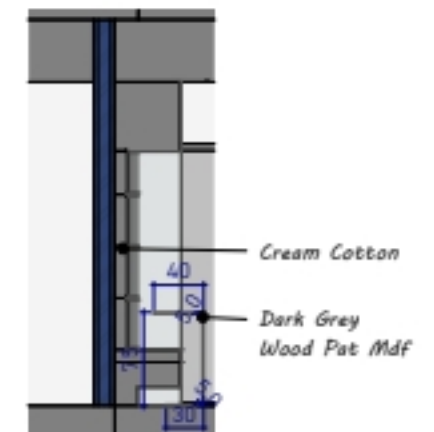

7. SECTION 13

1 : 50

PROJECT NAME : PAYARAVANKARAN Office

CLIENT : **PAYA RAVANKARAN ALBORZ**

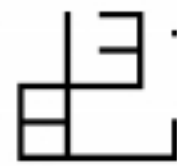

ARCHITECT : MAHSA RAHMATI

ABSAB ARCHITECTURAL DESIGN & CONSTRUCTION TEAM

1ST FLOOR-DINING ROOM-LAYOUT 05

Project number	A109
Date	
Issue Date	
Drawn by	
Project Size :	A3
Scale	

No.	Description	Date

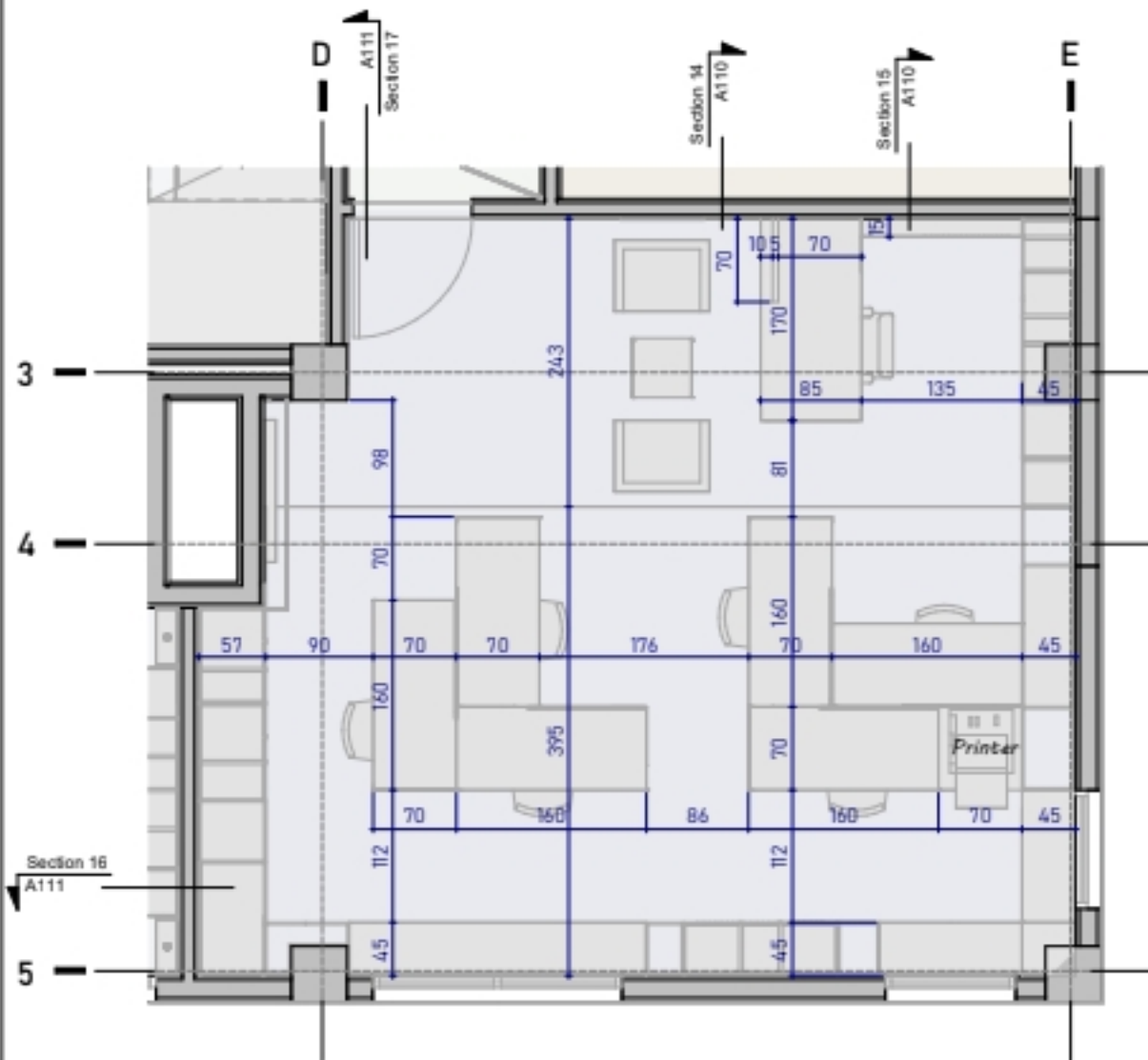

1. FIRST -FINANCIAL ROOM-LAYOUT 06

1 : 50

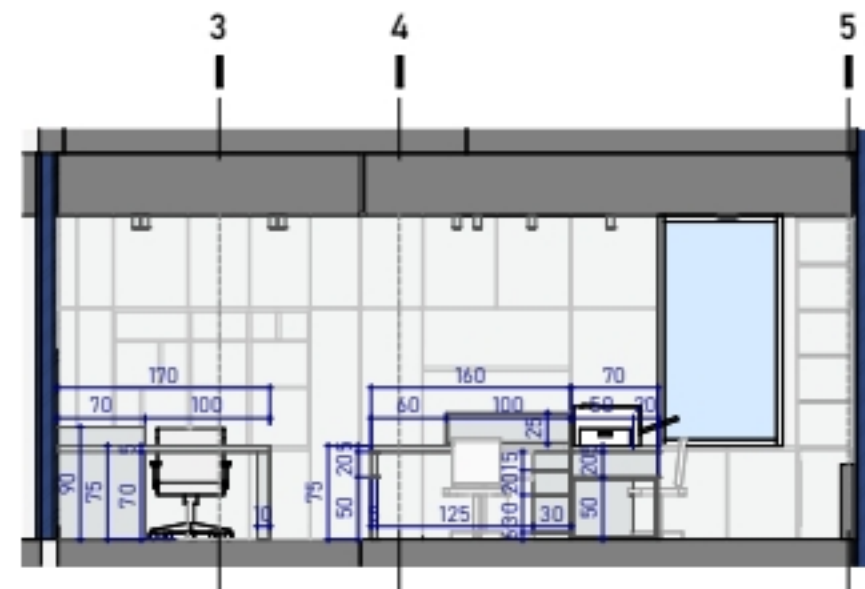

2. SECTION 14

1 : 50

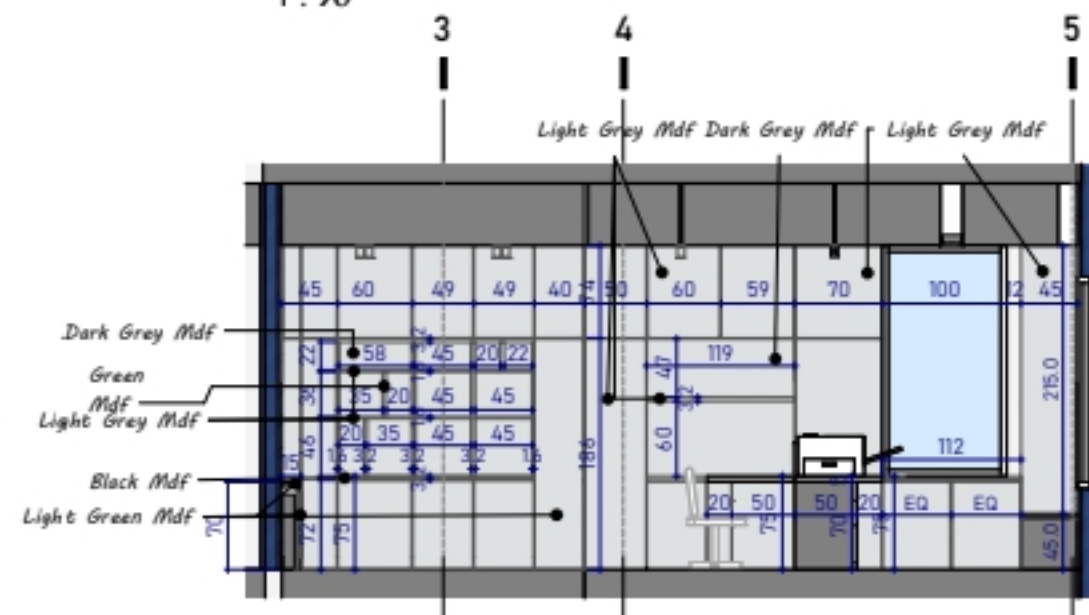

3. SECTION 15

1 : 50

PROJECT NAME : PAYARAVANKARAN Office

CLIENT : **PAYA RAVANKARAN ALBORZ**

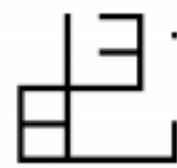

ARCHITECT : MAHSA RAHMATI

ABSAB ARCHITECTURAL DESIGN & CONSTRUCTION TEAM

1ST FLOOR-FINANCIAL ROOM-LAYOUT 06

Project number

Date

Drawn by

Paper Size :

Issue Date

Scale

A110

No.	Description	Date

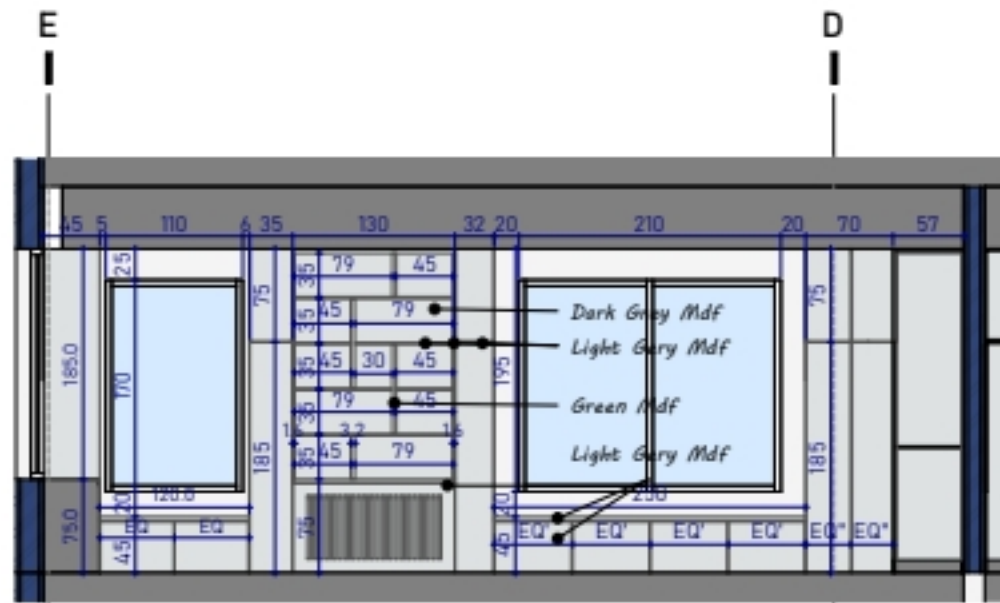

1. SECTION 16

1 : 50

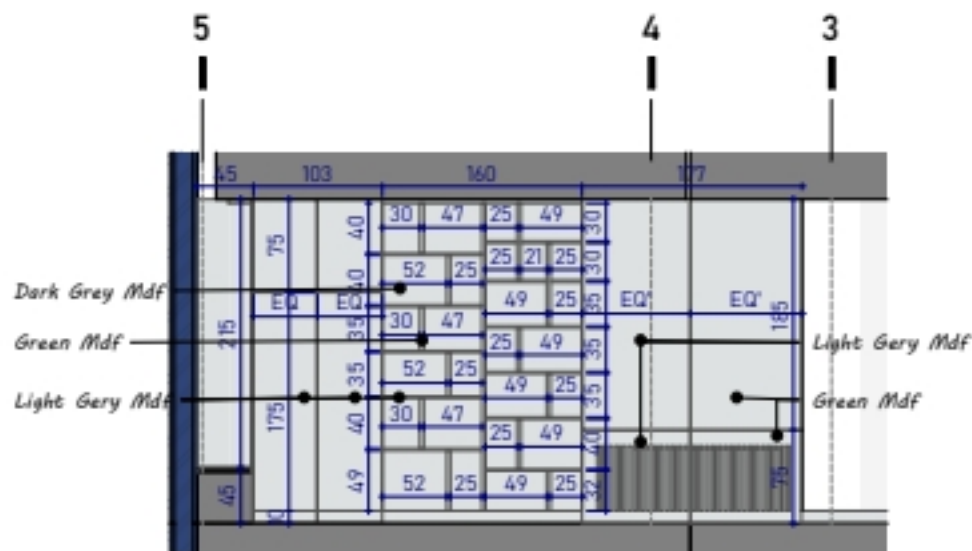

2. SECTION 17

1 : 50

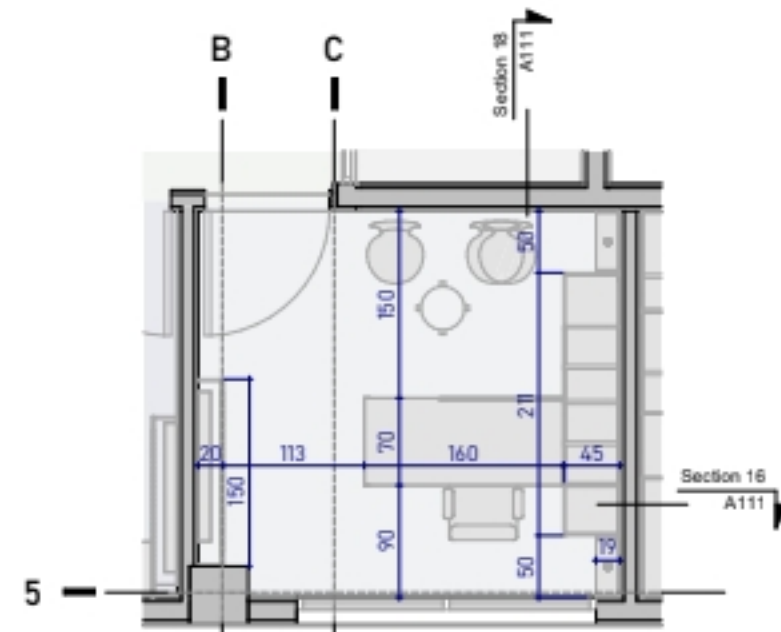

3. FIRST - LAYOUT 07

1 : 50

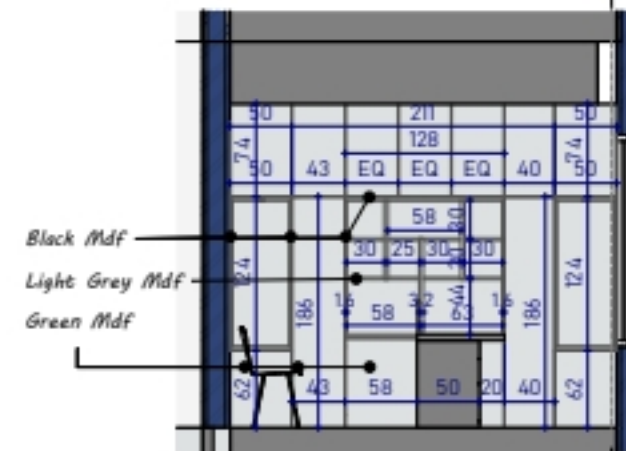

4. SECTION 18

1 : 50

PROJECT NAME : PAYARAVANKARAN Office

CLIENT : **PAYA RAVANKARAN ALBORZ**

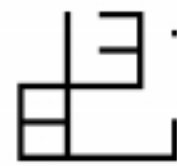

ARCHITECT : MAHSA RAHMATI

ABSAB ARCHITECTURAL DESIGN & CONSTRUCTION TEAM

1st Floor-Layout 06 & 07

Project number
Date Issue Date
Drawn by
Paper Size : A3

AIII

Scale

No.	Description	Date

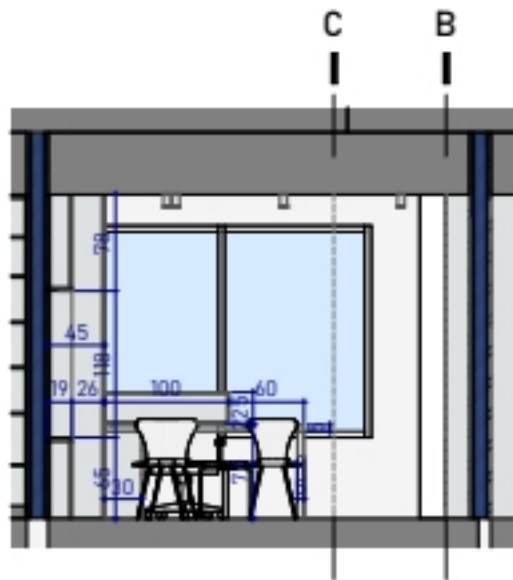

1. SECTION 19

1 : 50

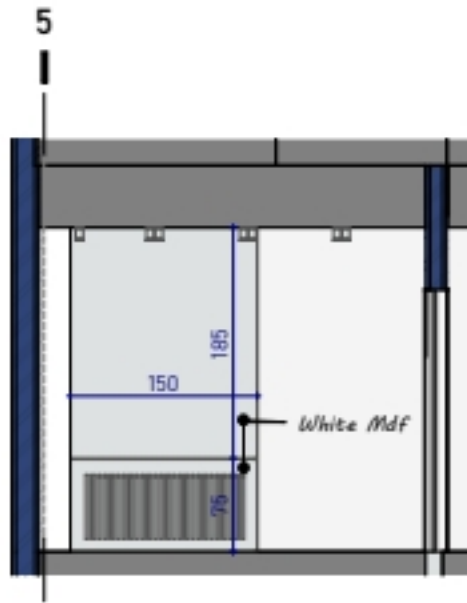

2. SECTION 20

1 : 50

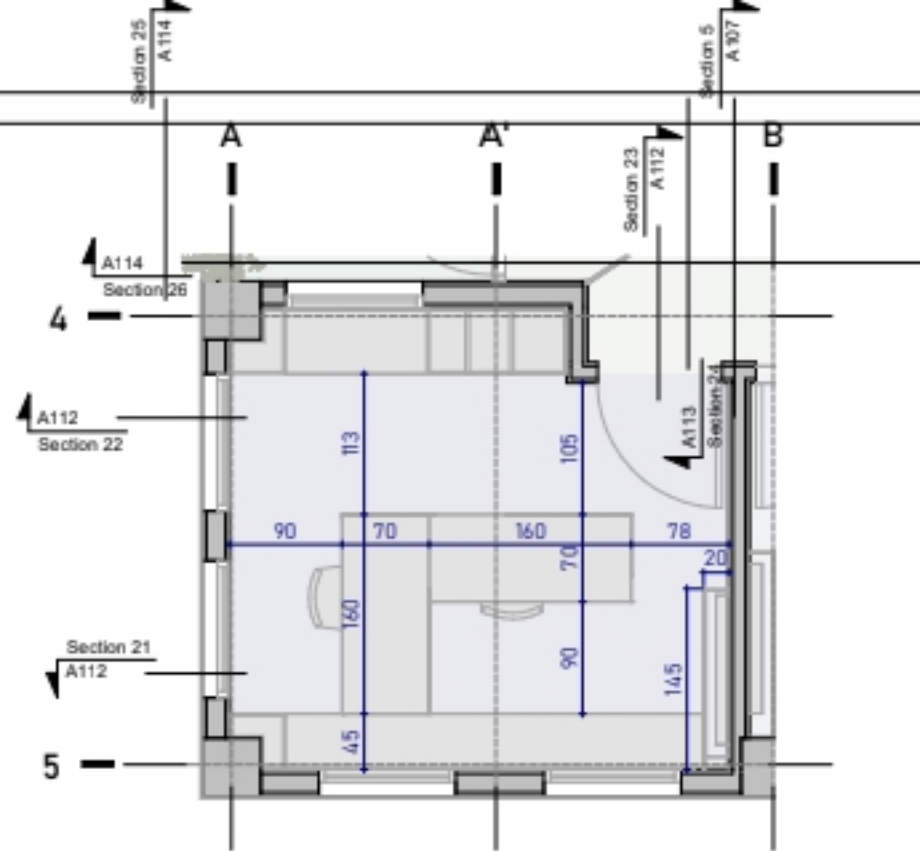

3. First-Layout 08

1 : 50

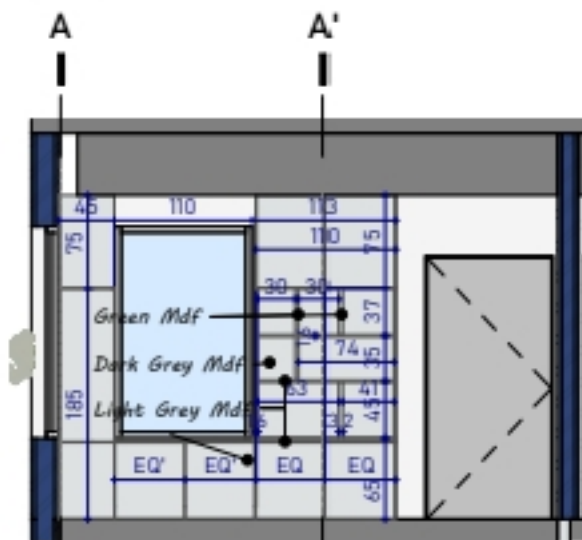

5. SECTION 22

1 : 50

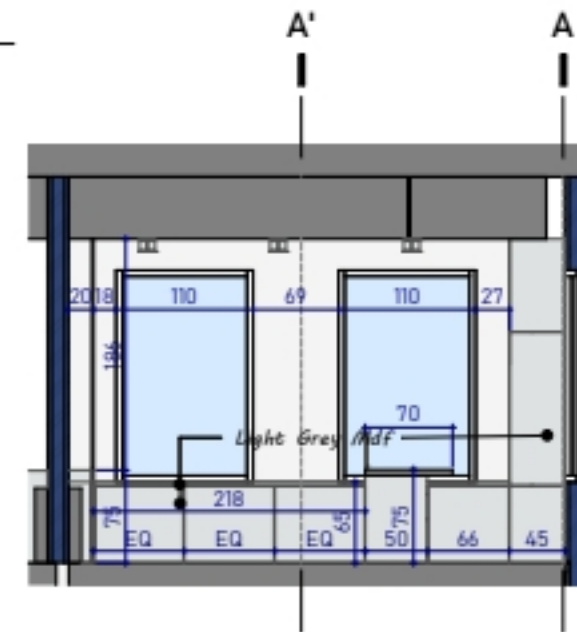

4. SECTION 21

1 : 50

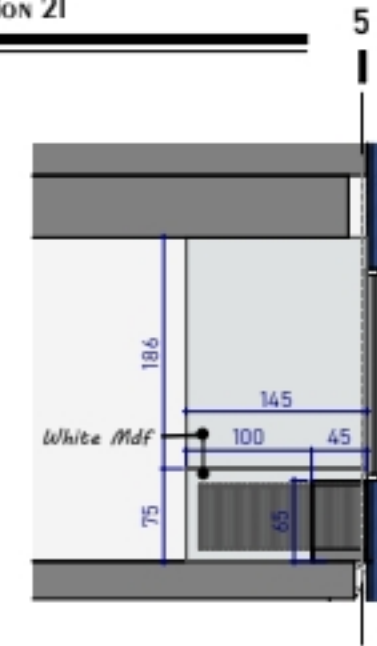

6. SECTION 23

1 : 50

PROJECT NAME : PAYARAVANKARAN Office

CLIENT : **PAYA RAVANKARAN ALBORZ**

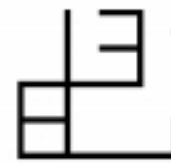

ARCHITECT : MAHSA RAHMATI

ABSAB ARCHITECTURAL DESIGN & CONSTRUCTION TEAM

1st Floor-Layout 07 & 08

Project number
Date Issue Date
Drawn by
Paper Size : A3

All2

Scale

No.	Description	Date

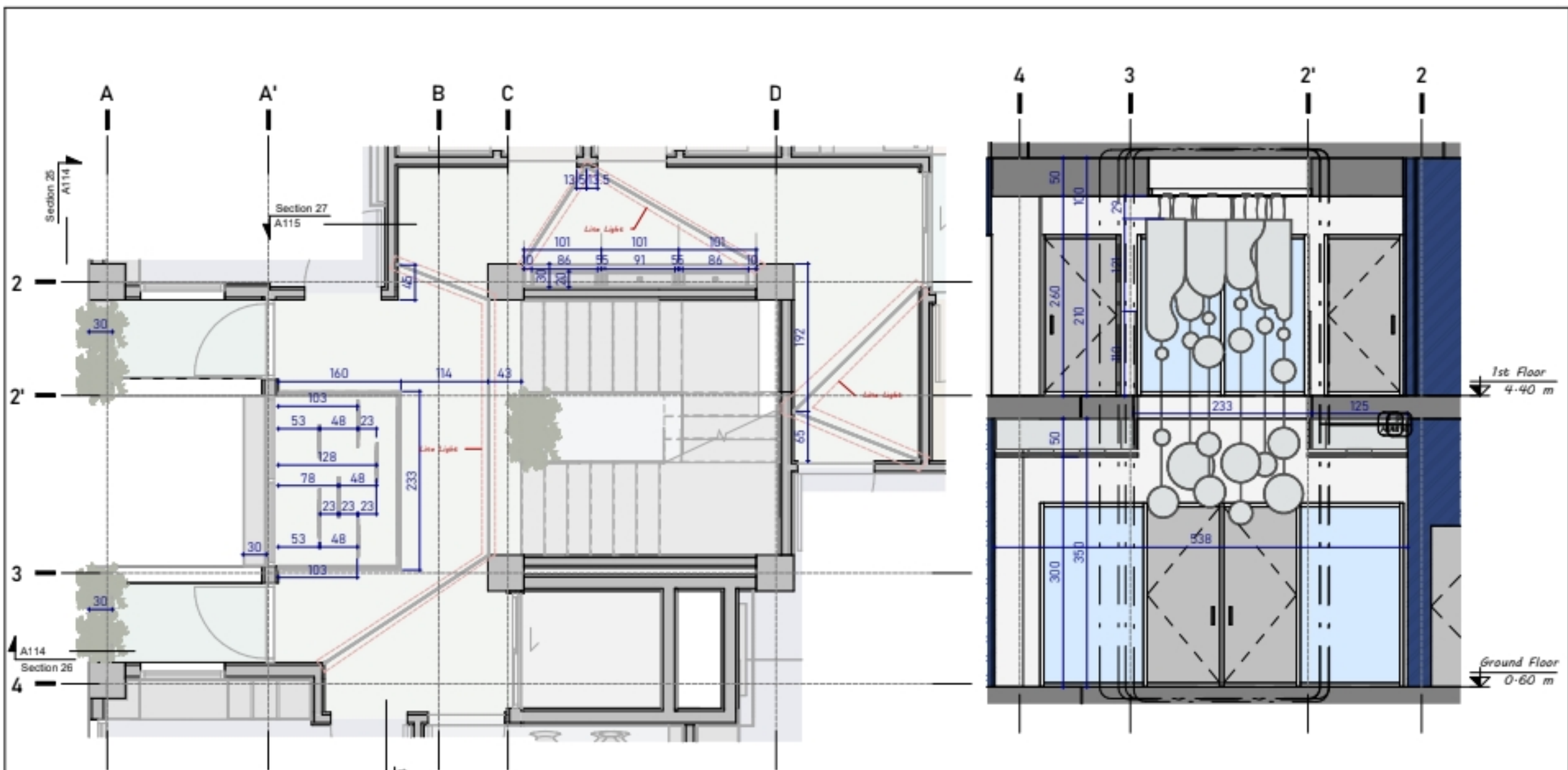

1. FIRST-CORRIDOR-LAYOUT 09
1 : 50

2. SECTION 24
1 : 50

PROJECT NAME : PAYARAVANKARAN Office
CLIENT : **PAYA RAVANKARAN ALBORZ**

ARCHITECT : MAHSA RAHMATI
ABSAB ARCHITECTURAL DESIGN & CONSTRUCTION TEAM

1ST FLOOR-LAYOUT 09
Project number: _____
Date: _____ Issue Date: _____
Drawn by: _____
Paper Size: A3 Scale: _____

No.	Description	Date

30.03.2023 5:19:30 PM

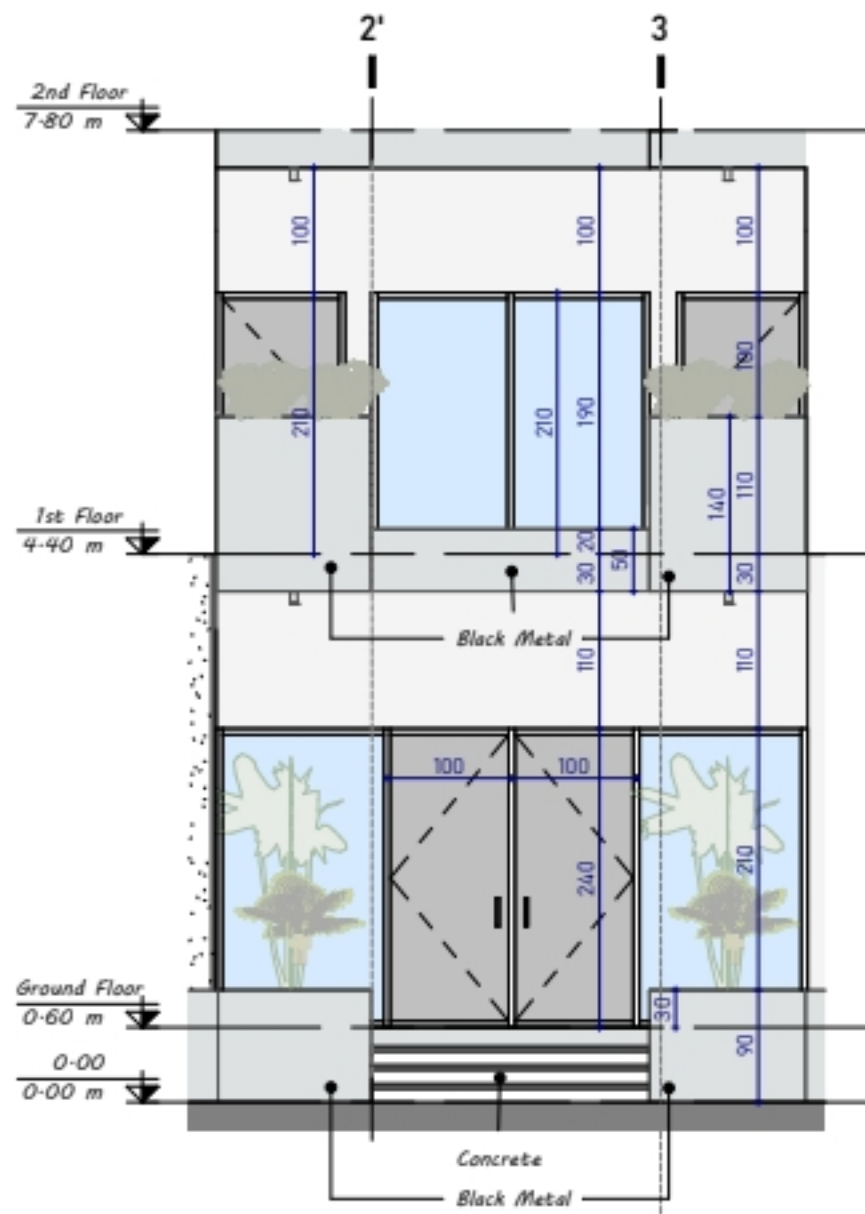

1. SECTION 25

1 : 50

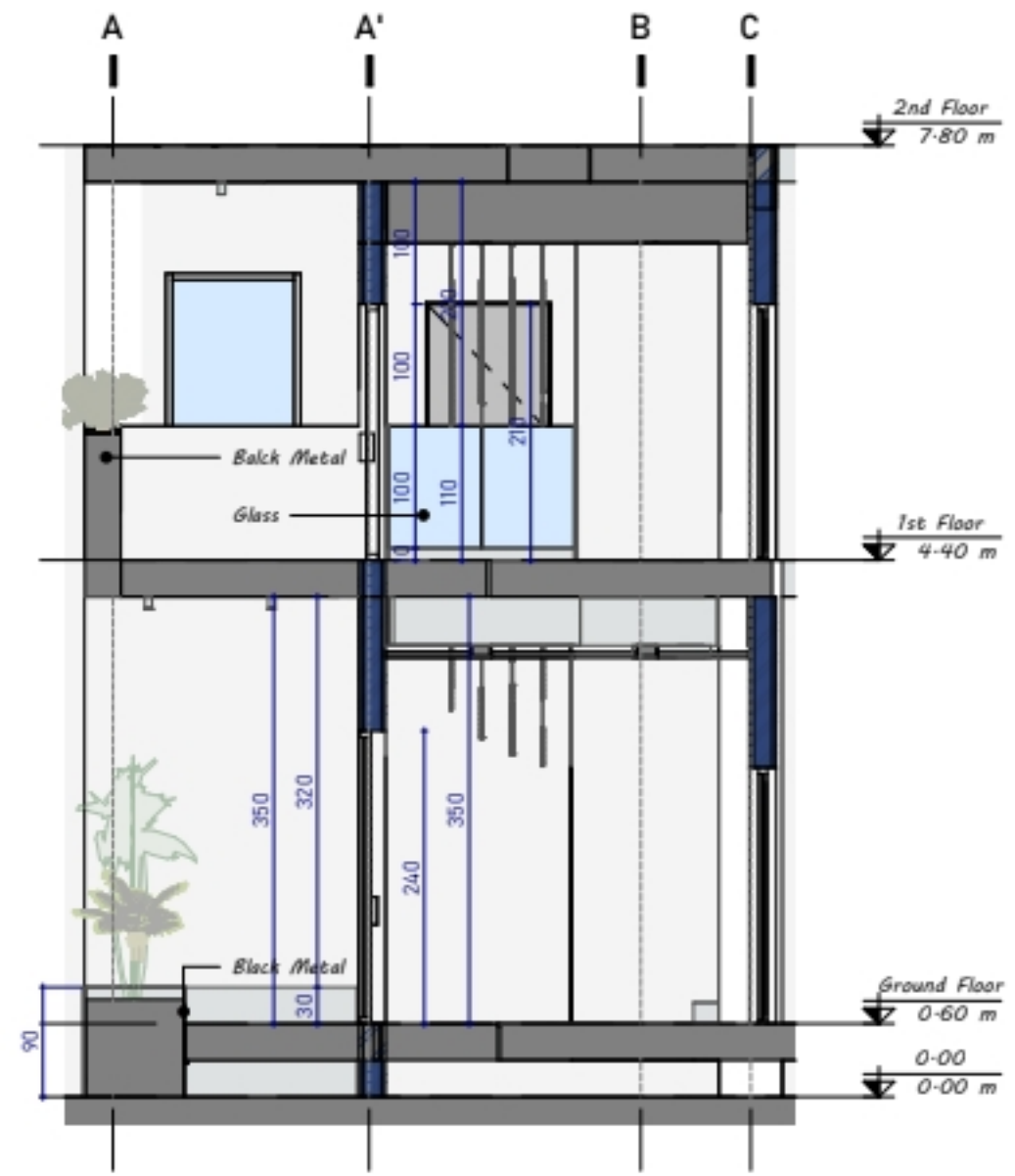

2. SECTION 26

1 : 50

PROJECT NAME : PAYARAVANKARAN Office
 CLIENT : **PAYA RAVANKARAN ALBORZ**

ARCHITECT : MAHSA RAHMATI
ABSAB ARCHITECTURAL DESIGN & CONSTRUCTION TEAM

1st Floor-Layout 09
 Project number
 Date Issue Date
 Drawn by
 Paper Size : A3 Scale
All4

No.	Description	Date

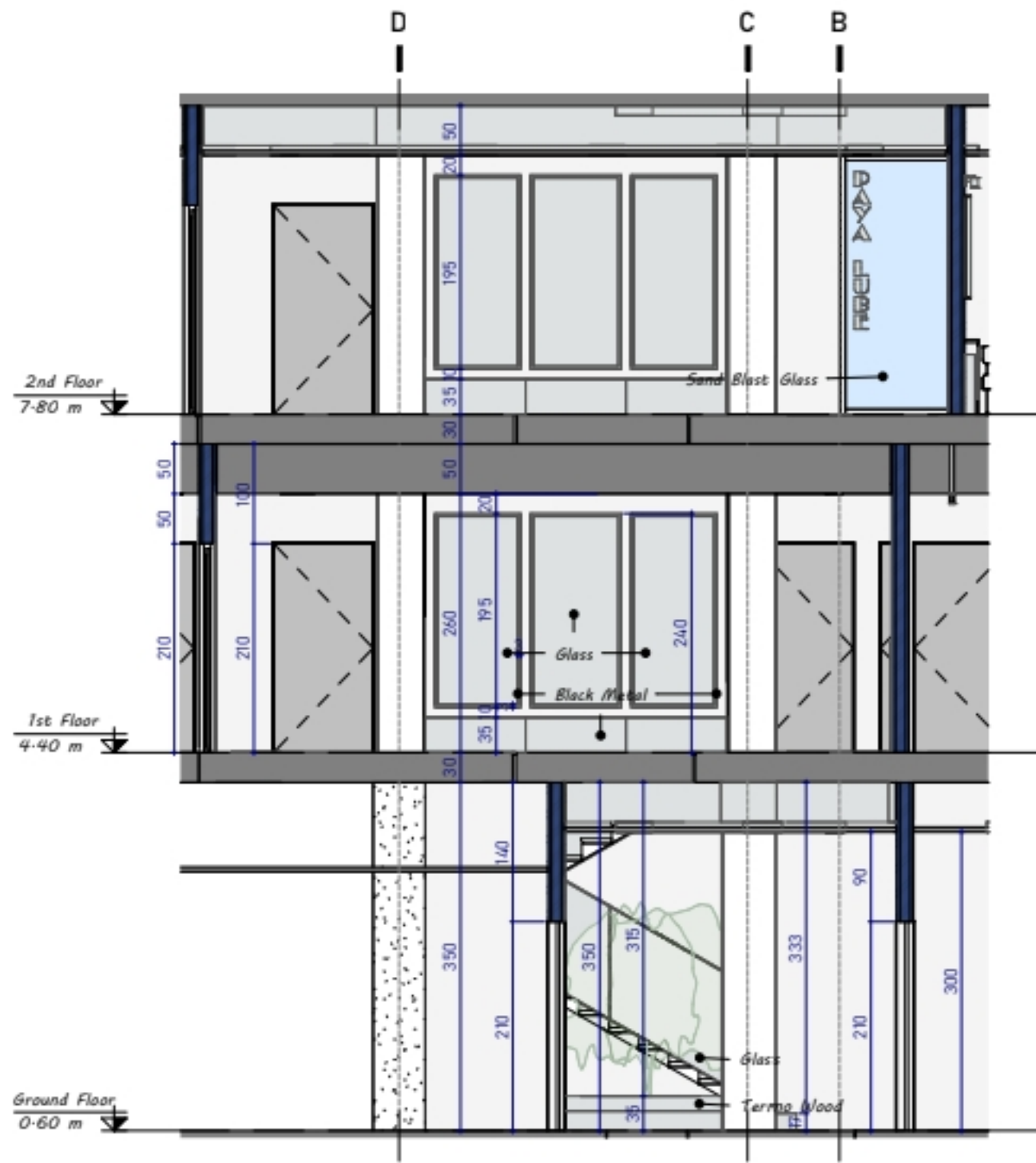

1. SECTION 27

1 : 50

PROJECT NAME : PAYARAVANKARAN Office

CLIENT : **PAYA RAVANKARAN ALBORZ**

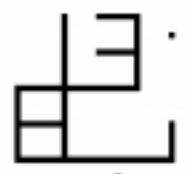

ARCHITECT : MAHSA RAHMATI

ABSAB ARCHITECTURAL DESIGN & CONSTRUCTION TEAM

Ist Floor-Layout 09

Project number	
Date	Issue Date
Drawn by	
Paper Size :	A3

A115

Scale

No.	Description	Date

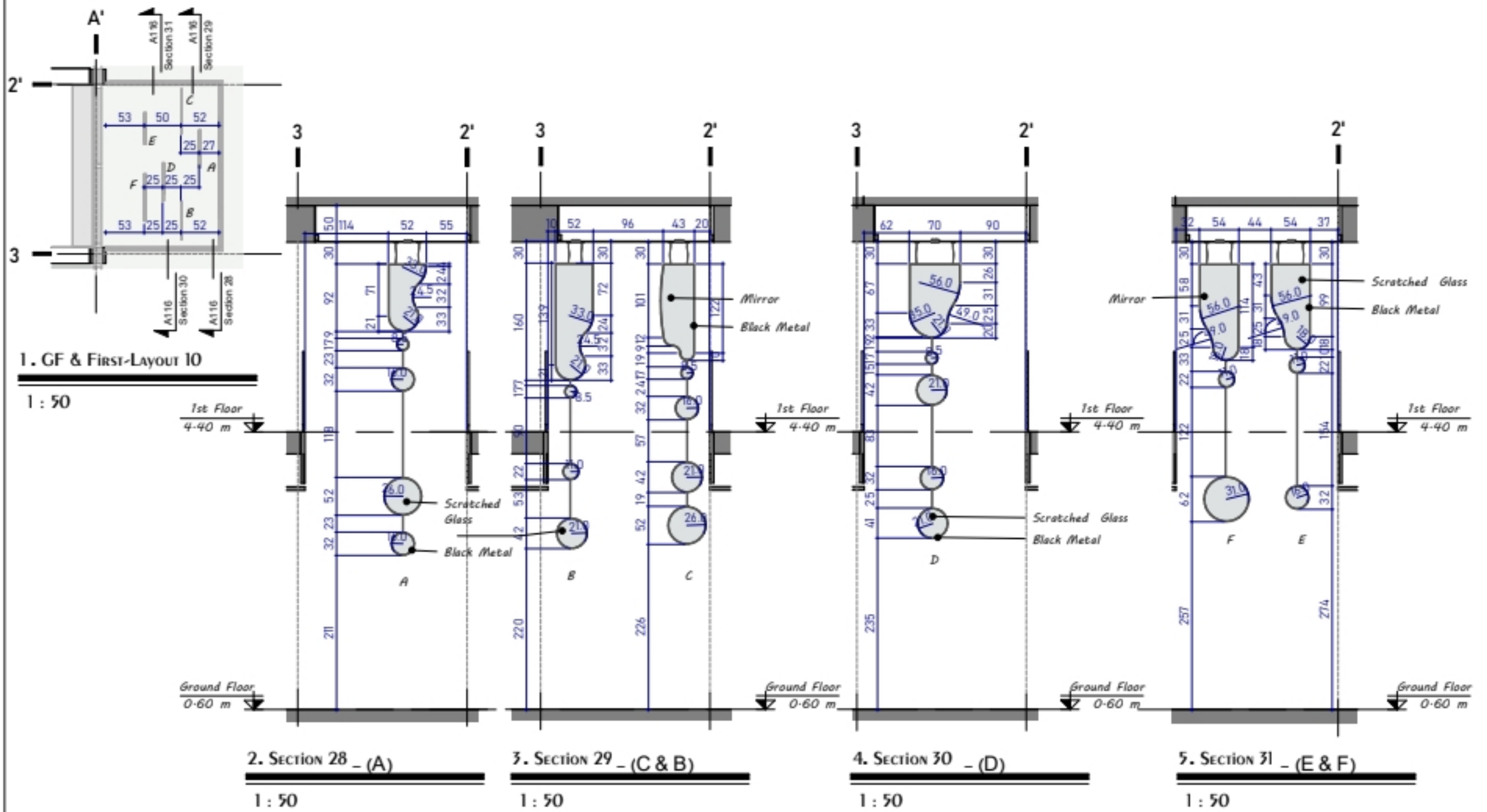

PROJECT NAME : PAYARAVANKARAN Office

CLIENT : **PAYA RAVANKARAN ALBORZ**

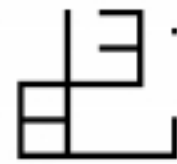

ARCHITECT : MAHSA RAHMATI

ABSAB ARCHITECTURAL DESIGN & CONSTRUCTION TEAM

GF & 1ST FLOOR-LAYOUT 10

Project number

Date

Drawn by

Paper Size :

Issue Date

All6

Scale

No.	Description	Date

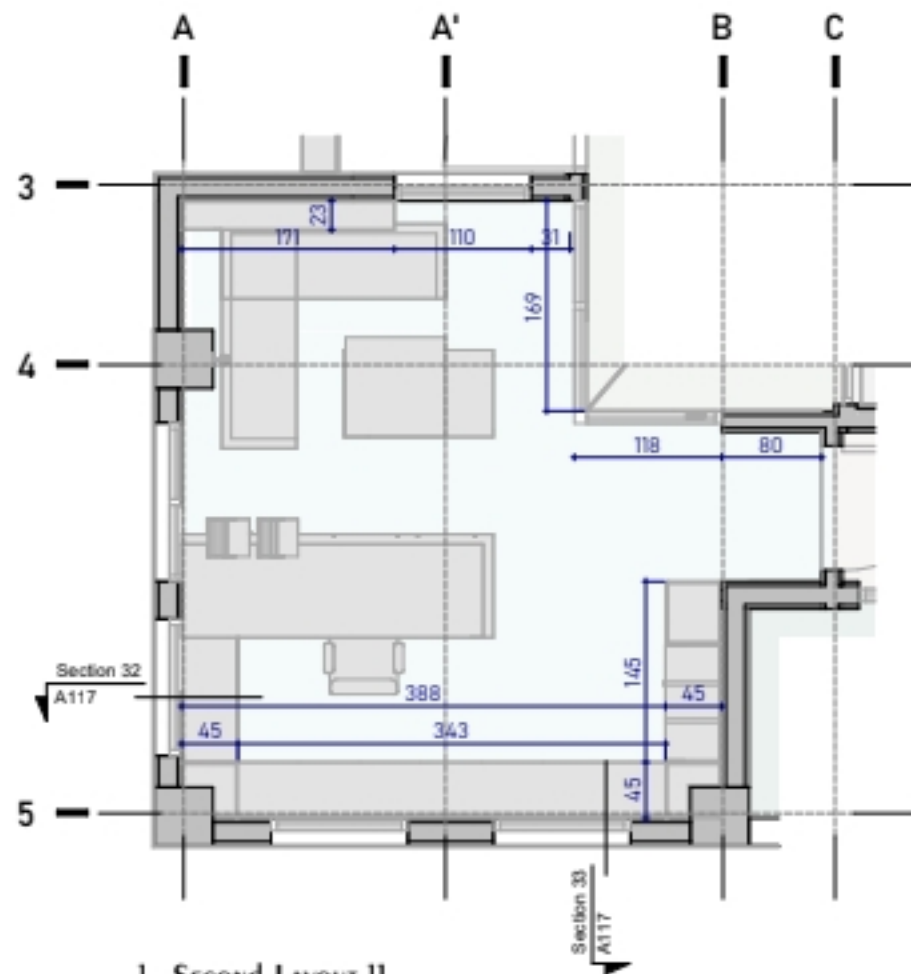

1. Second-Layout II

1 : 50

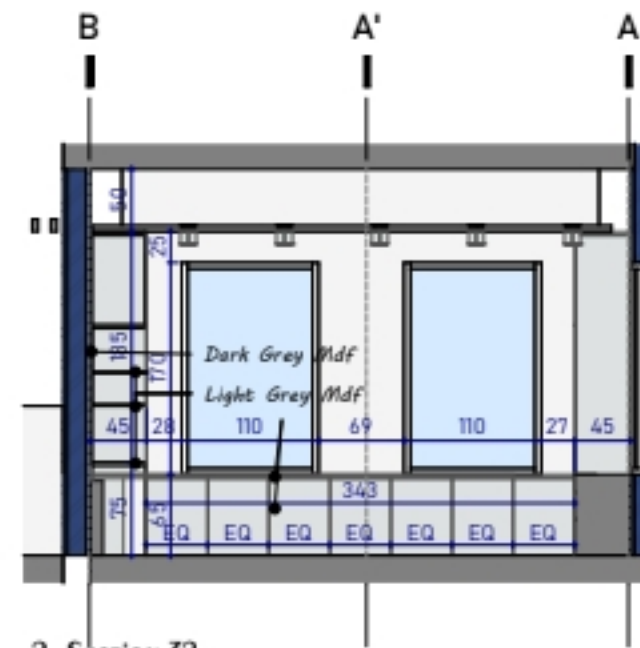

2. SECTION 32

1 : 50

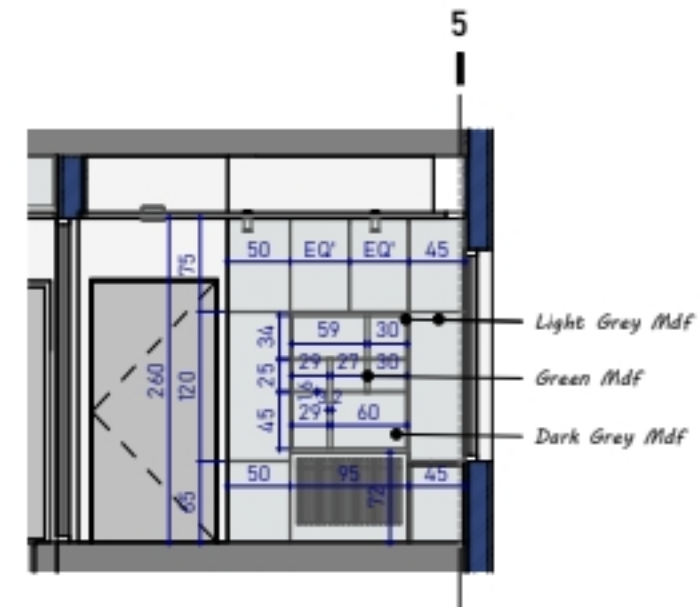

3. SECTION 33

1 : 50

PROJECT NAME : PAYARAVANKARAN Office

CLIENT : **PAYA RAVANKARAN ALBORZ**

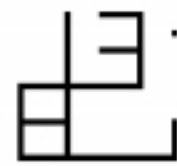

ARCHITECT : MAHSA RAHMATI

ABSAB ARCHITECTURAL DESIGN & CONSTRUCTION TEAM

2nd Floor-Layout II

Project number
Date Issue Date
Drawn by
Paper Size : A3

A117

Scale

No.	Description	Date

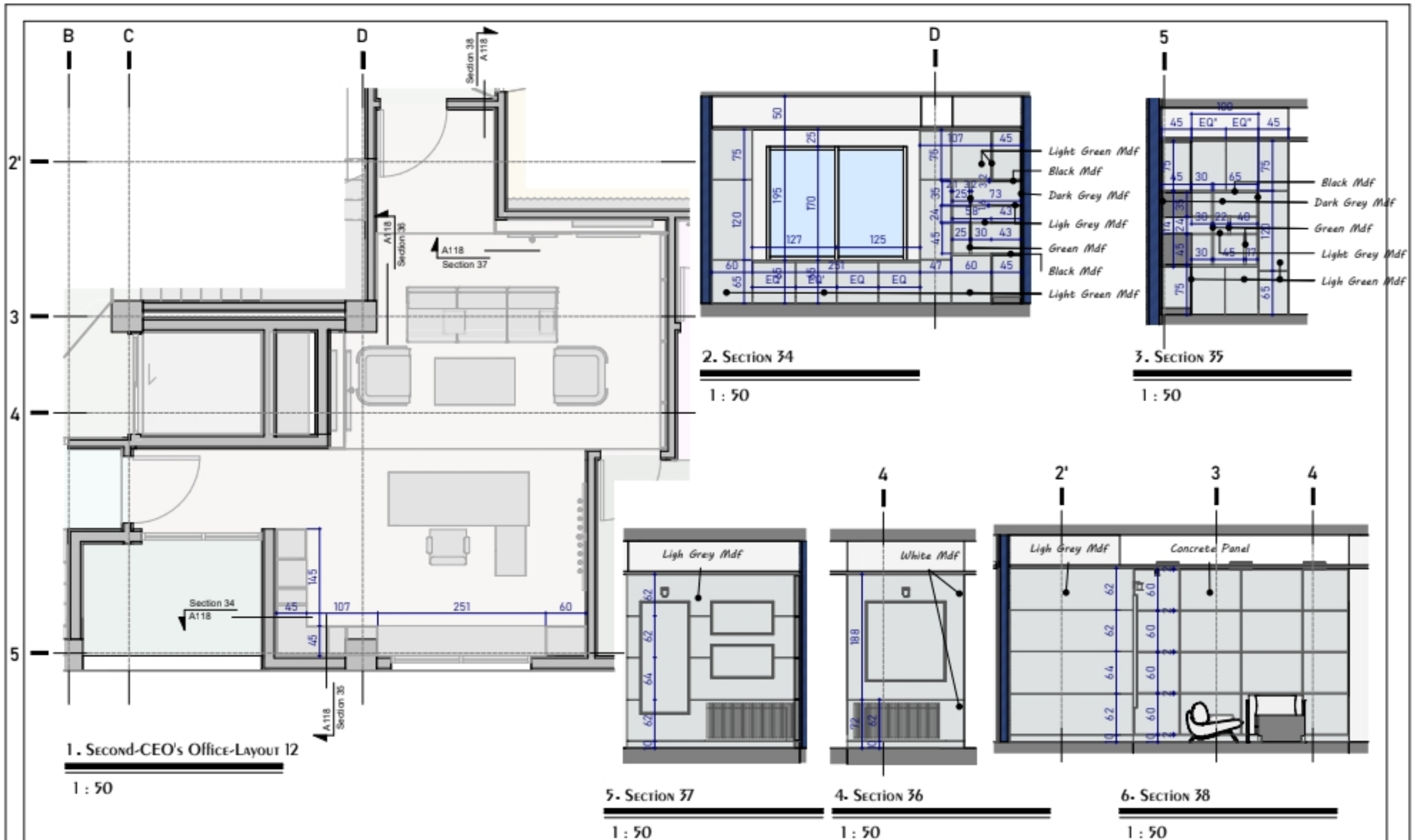

PROJECT NAME : PAYARAVANKARAN Office

CLIENT : **PAYA RAVANKARAN ALBORZ**

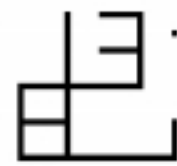

ARCHITECT : MAHSA RAHMATI

ABSAB ARCHITECTURAL DESIGN & CONSTRUCTION TEAM

2nd Floor-CEO Office-Layout 12

Project number

Date

Drawn by

Paper Size :

Issue Date

All8

Scale

No.	Description	Date

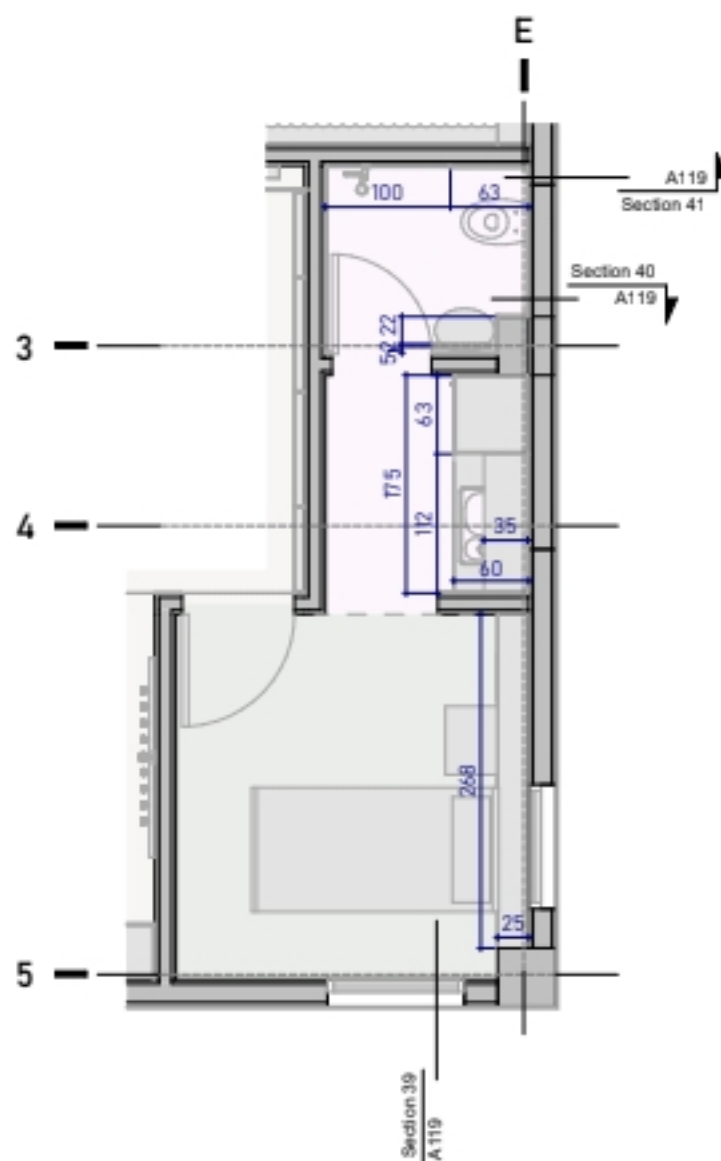

1. SECOND-CEO'S SUITE-LAYOUT B3
1 : 50

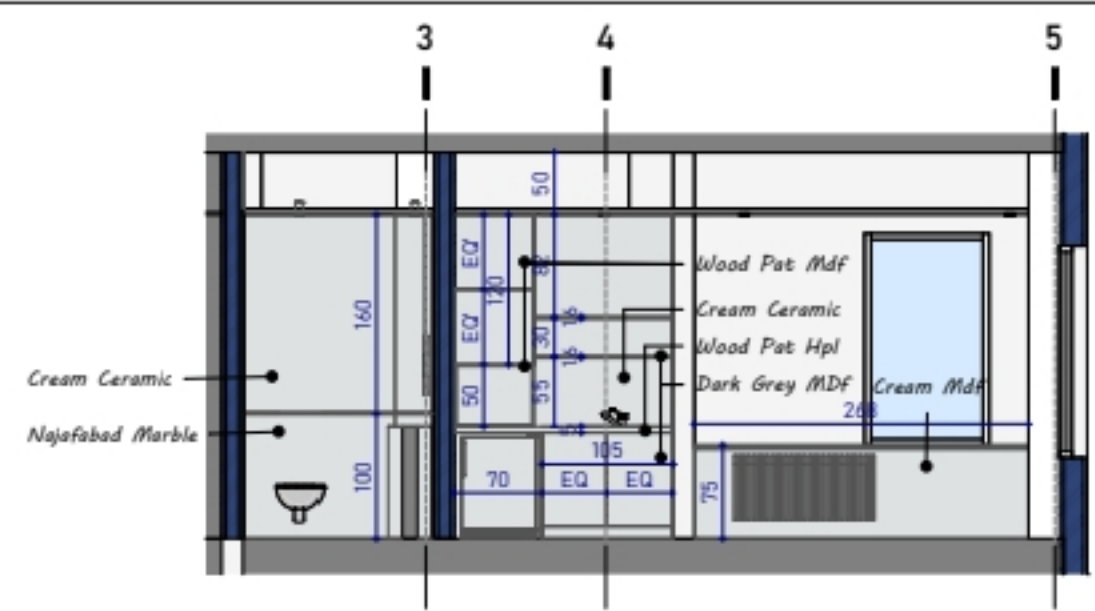

2. SECTION 39
1 : 50

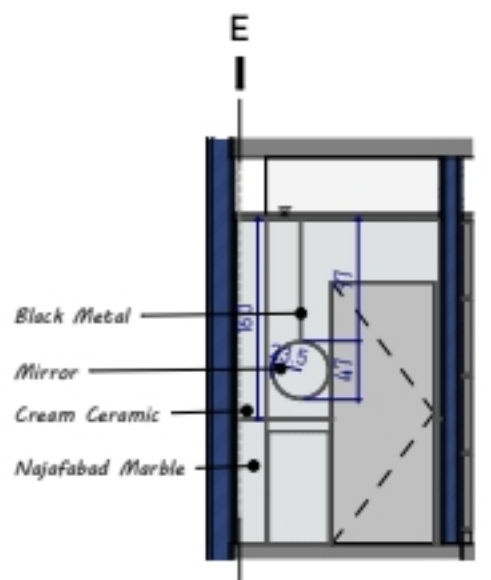

3. SECTION 40
1 : 50

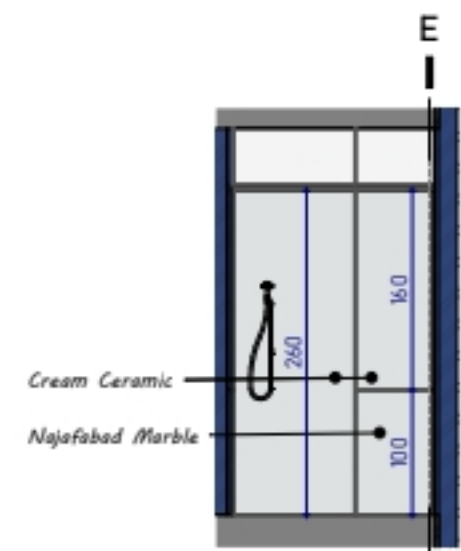

4. SECTION 41
1 : 50

PROJECT NAME : PAYARAVANKARAN Office
CLIENT : **PAYA RAVANKARAN ALBORZ**

ARCHITECT : MAHSA RAHMATI
ABSAB ARCHITECTURAL DESIGN & CONSTRUCTION TEAM

2nd FLOOR-CEO SUITE-LAYOUT B3
Project number: All9
Date: Issue Date
Drawn by:
Paper Size: A3 Scale

No.	Description	Date

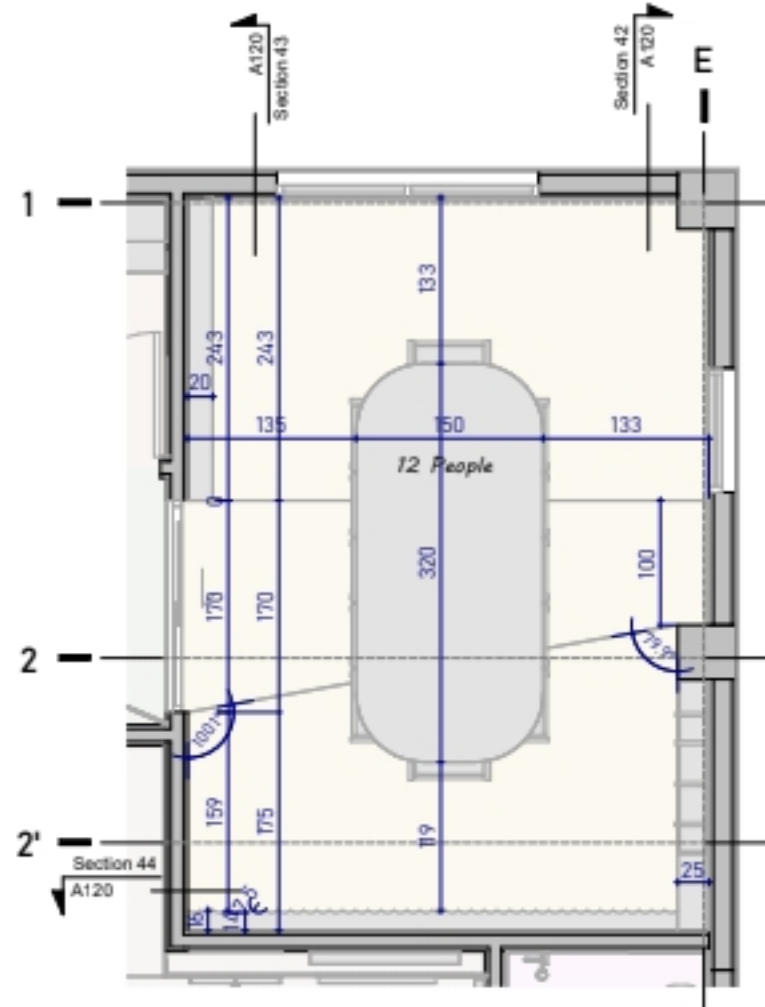

1. SECOND-CONFERENCE ROOM-LAYOUT 14

1 : 50

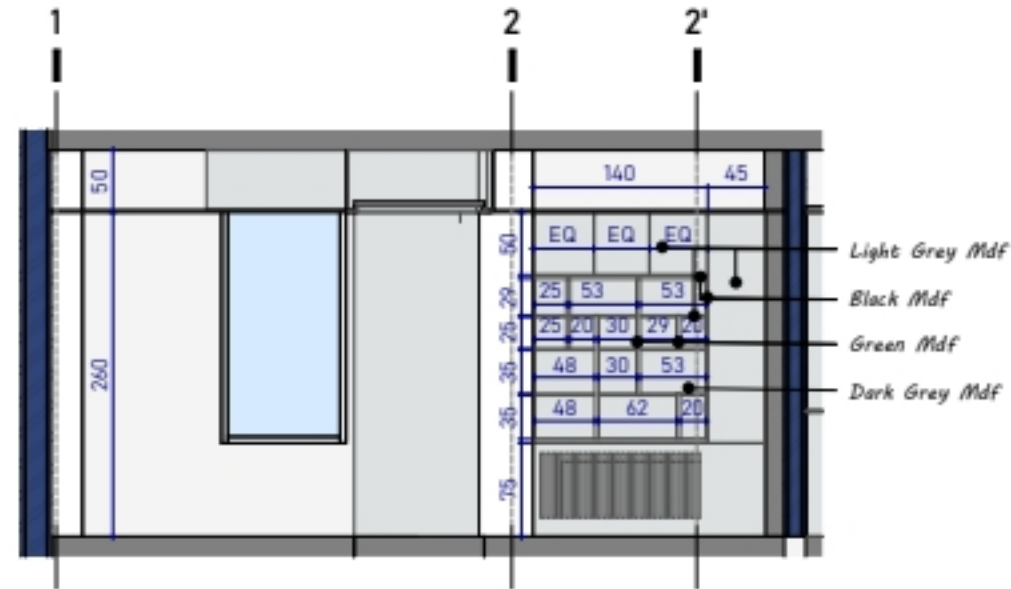

2. SECTION 42

1 : 50

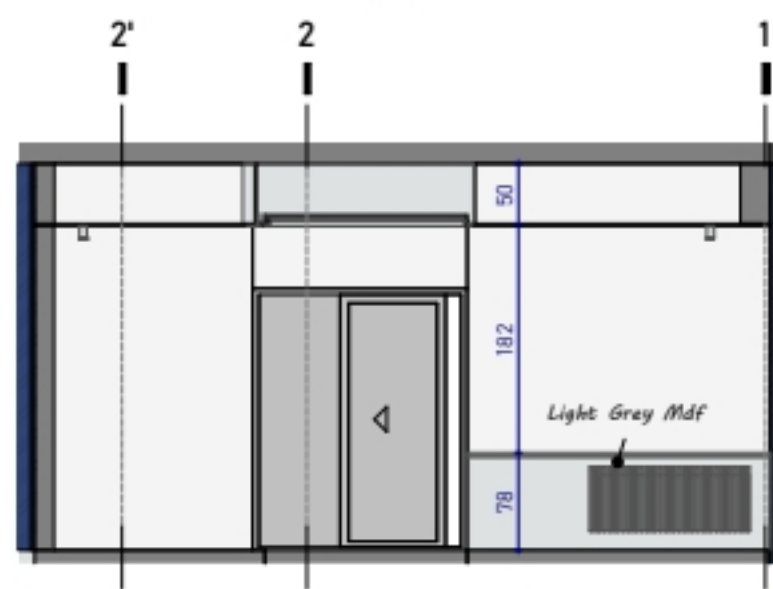

3. SECTION 43

1 : 50

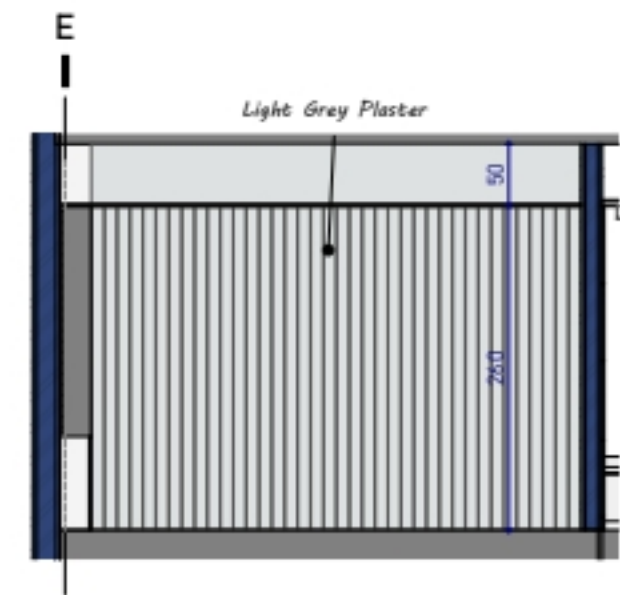

4. SECTION 44

1 : 50

PROJECT NAME : PAYARAVANKARAN Office

CLIENT : **PAYA RAVANKARAN ALBORZ**

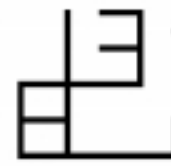

ARCHITECT : MAHSA RAHMATI

ABSAB ARCHITECTURAL DESIGN & CONSTRUCTION TEAM

2nd FLOOR-CONF ROOM-LAYOUT 14

Project number: A120
 Date: Issue Date
 Drawn by:
 Paper Size: A3 Scale

No.	Description	Date

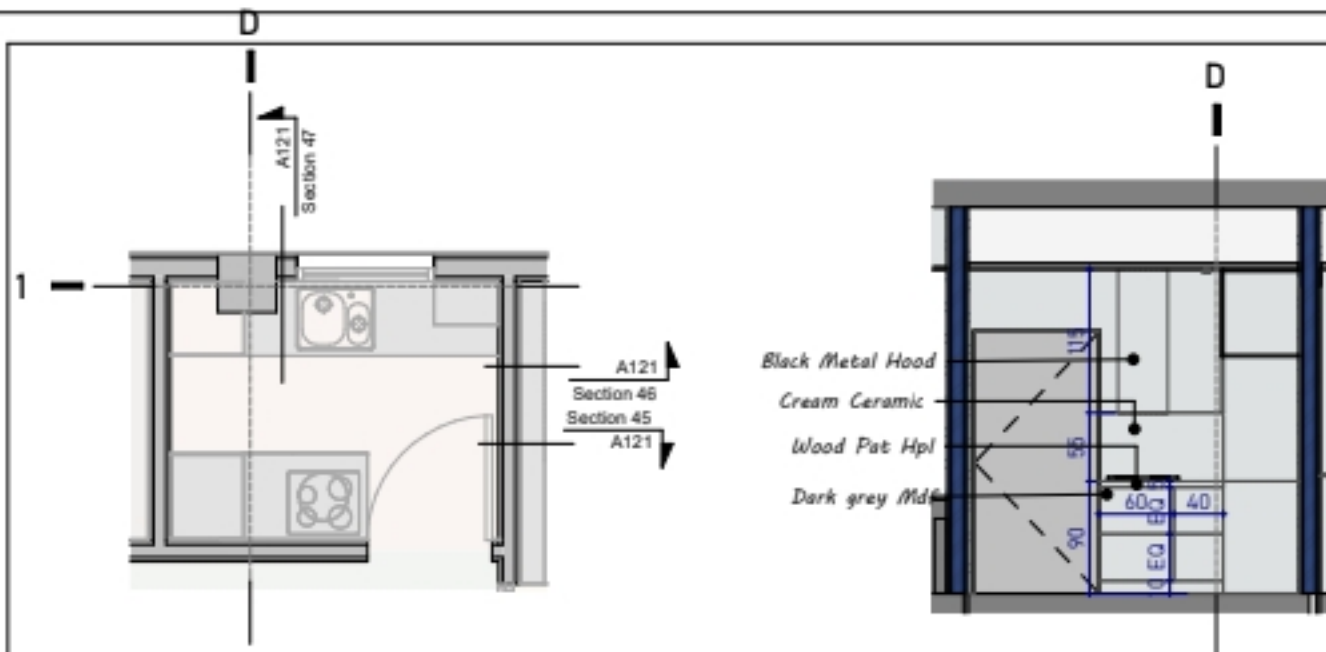

1. SECOND-KITCHEN-LAYOUT 15

1 : 50

2. SECTION 45

1 : 50

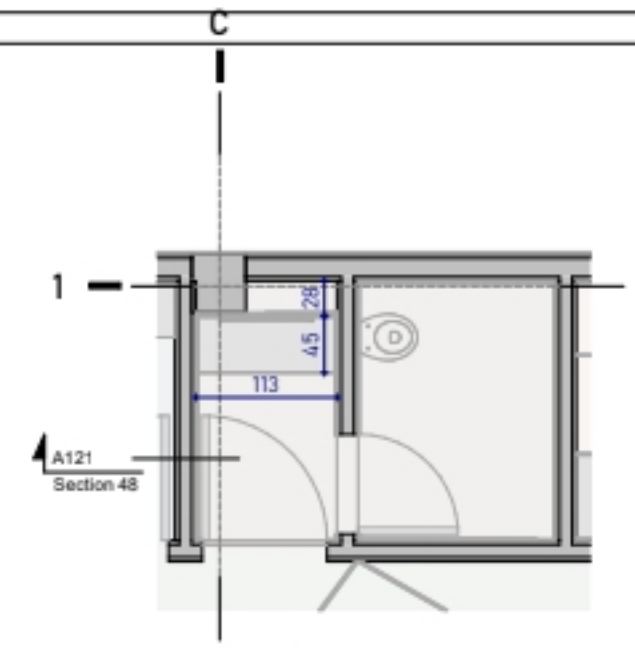

5. SECOND-LAYOUT 16

1 : 50

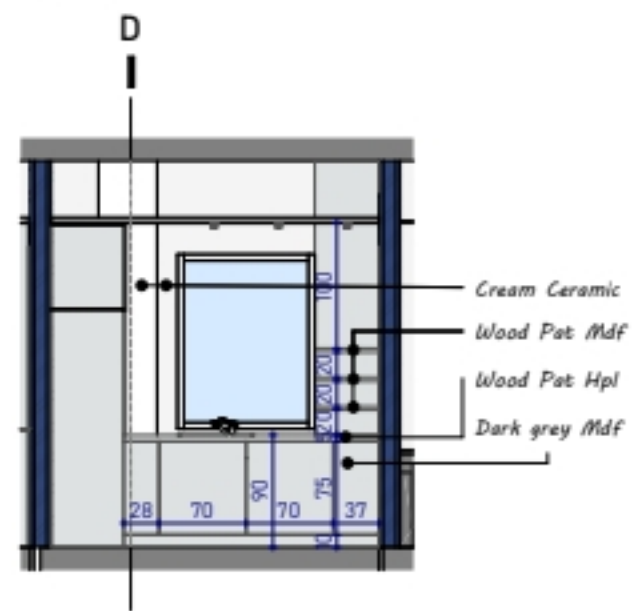

3. SECTION 46

1 : 50

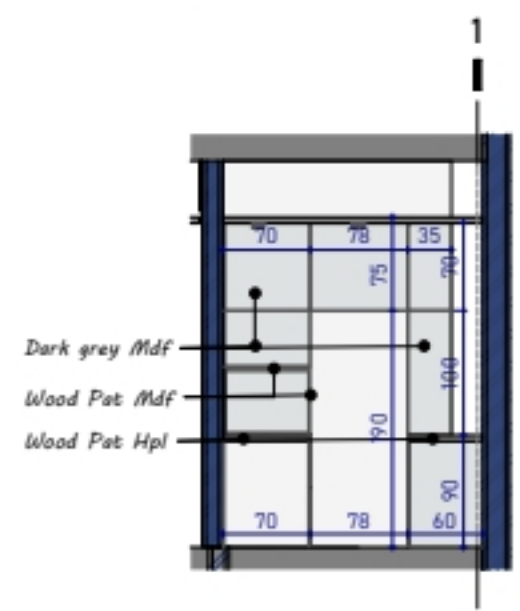

4. SECTION 47

1 : 50

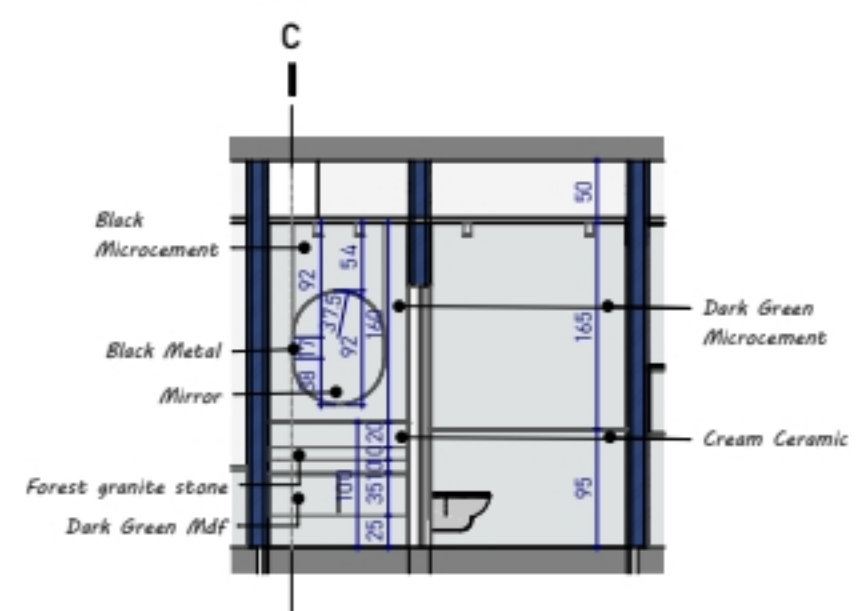

6. SECTION 48

1 : 50

PROJECT NAME : PAYARAVANKARAN Office
 CLIENT : **PAYA RAVANKARAN ALBORZ**

ARCHITECT : MAHSA RAHMATI
ABSAB ARCHITECTURAL DESIGN & CONSTRUCTION TEAM

2nd FLOOR-LAYOUT 15 & 16
 Project number: A121
 Date: Issue Date: A121
 Drawn by:
 Paper Size: A3 Scale:

No.	Description	Date

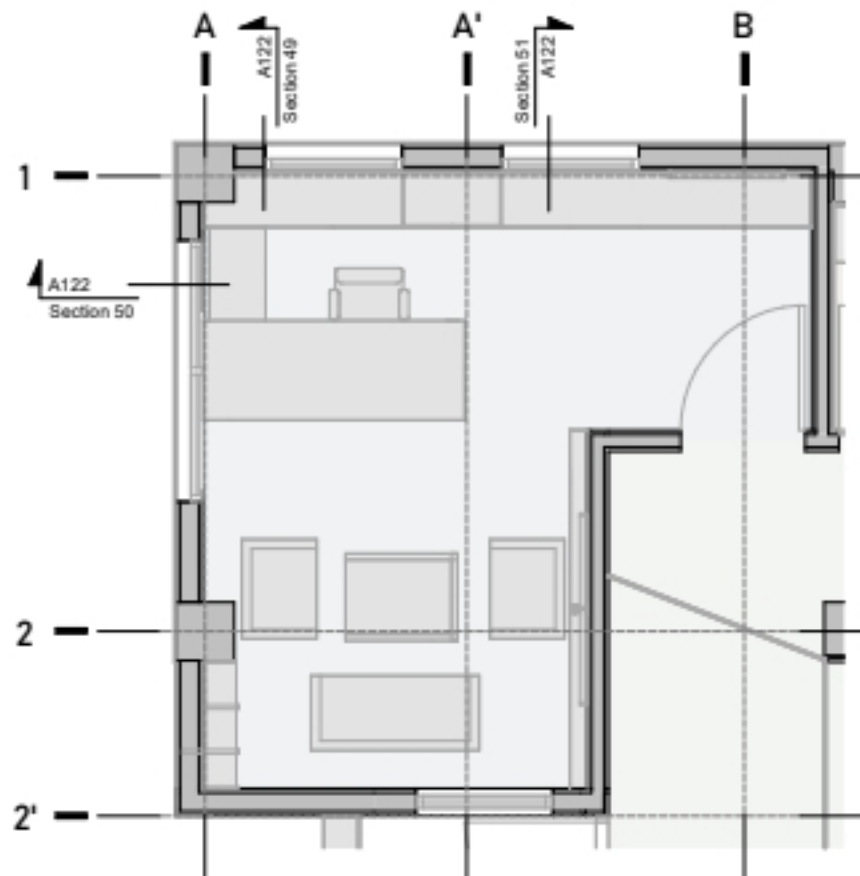

2. SECTION 49
1 : 50

1. SECOND-MANAGER OFFICE-LAYOUT I7
1 : 50

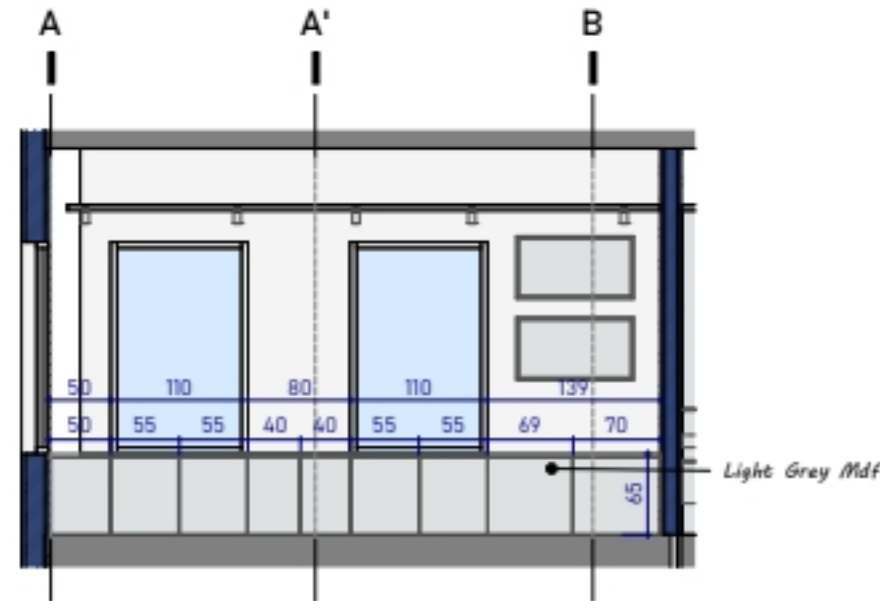

3. SECTION 50
1 : 50

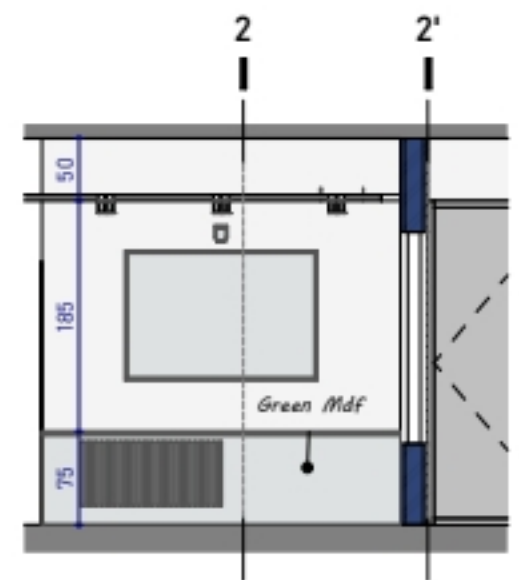

4. SECTION 51
1 : 50

PROJECT NAME : PAYARAVANKARAN Office
CLIENT : **PAYA RAVANKARAN ALBORZ**

ARCHITECT : MAHSA RAHMATI
ABSAB ARCHITECTURAL DESIGN & CONSTRUCTION TEAM

2nd FLOOR-MANAGER OFFICE-LAYOUT I7
Project number: A122
Date: _____ Issue Date: _____
Drawn by: _____
Paper Size: A3 Scale: _____

No.	Description	Date

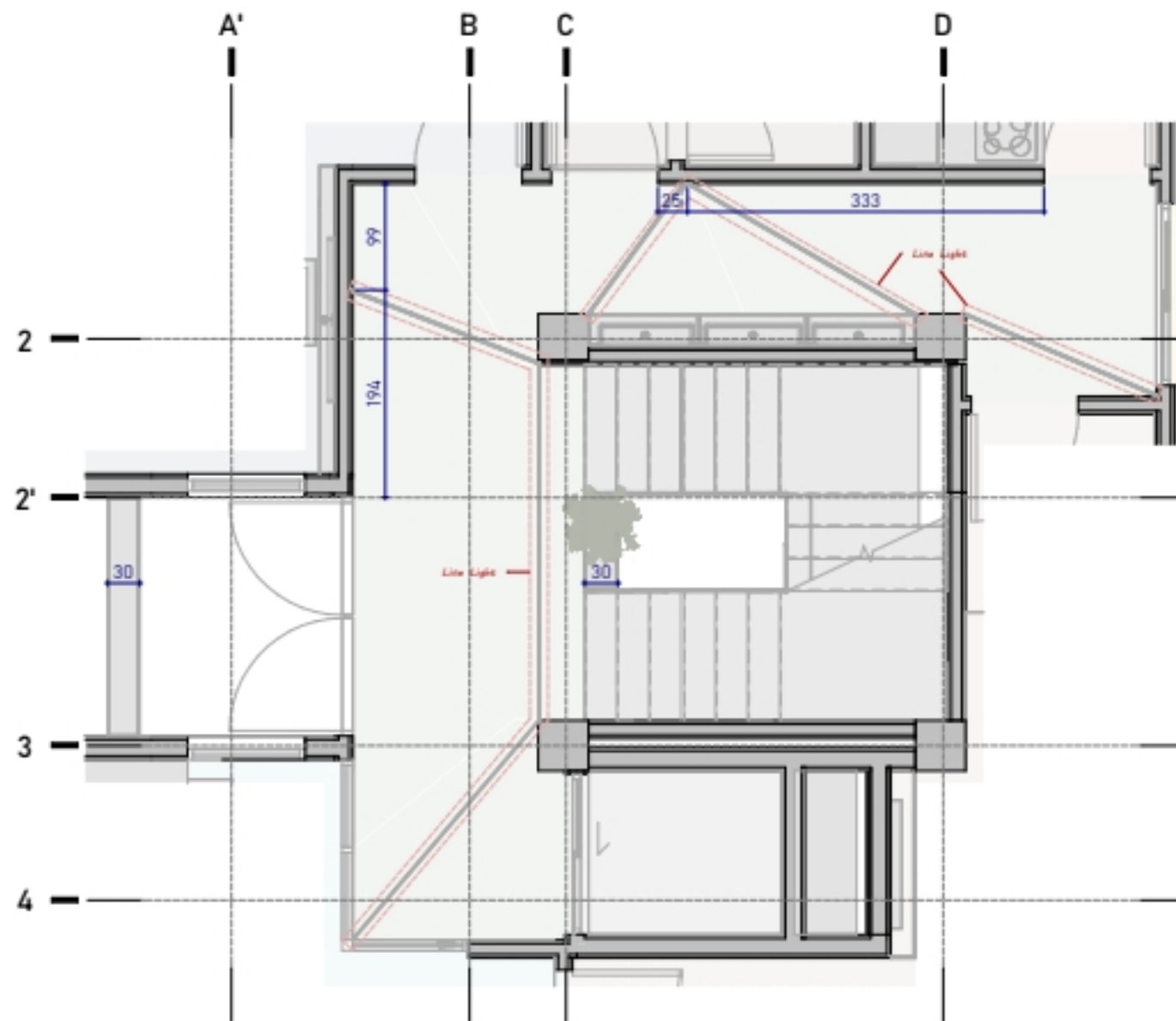

1. SECOND-CORRIDOR-LAYOUT18

1 : 50

PROJECT NAME : PAYARAVANKARAN Office

CLIENT : **PAYA RAVANKARAN ALBORZ**

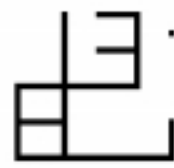

ARCHITECT : MAHSA RAHMATI

ABSAB ARCHITECTURAL DESIGN & CONSTRUCTION TEAM

2nd FLOOR-CORRIDOR-LAYOUT18

Project number
Date Issue Date
Drawn by
Paper Size : A3

A123

Scale

No.	Description	Date

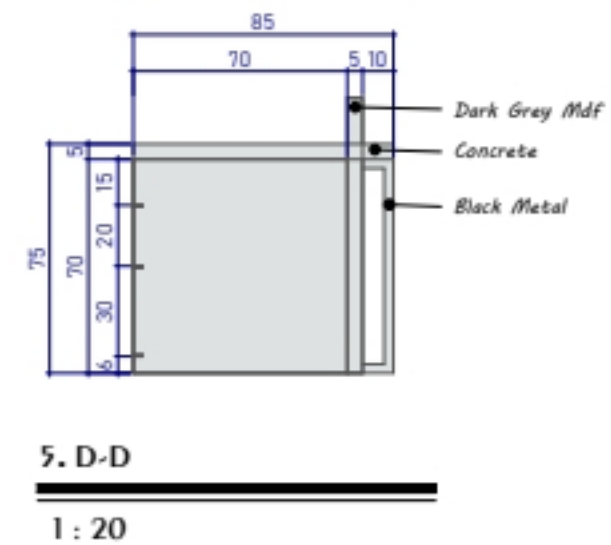
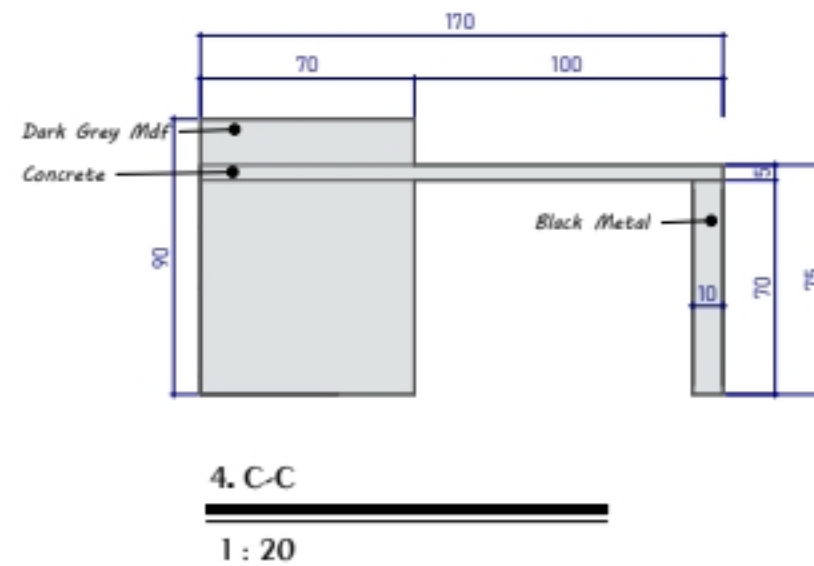
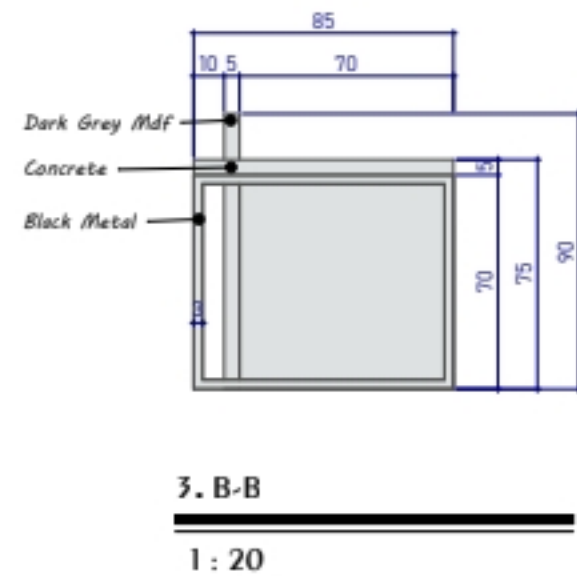
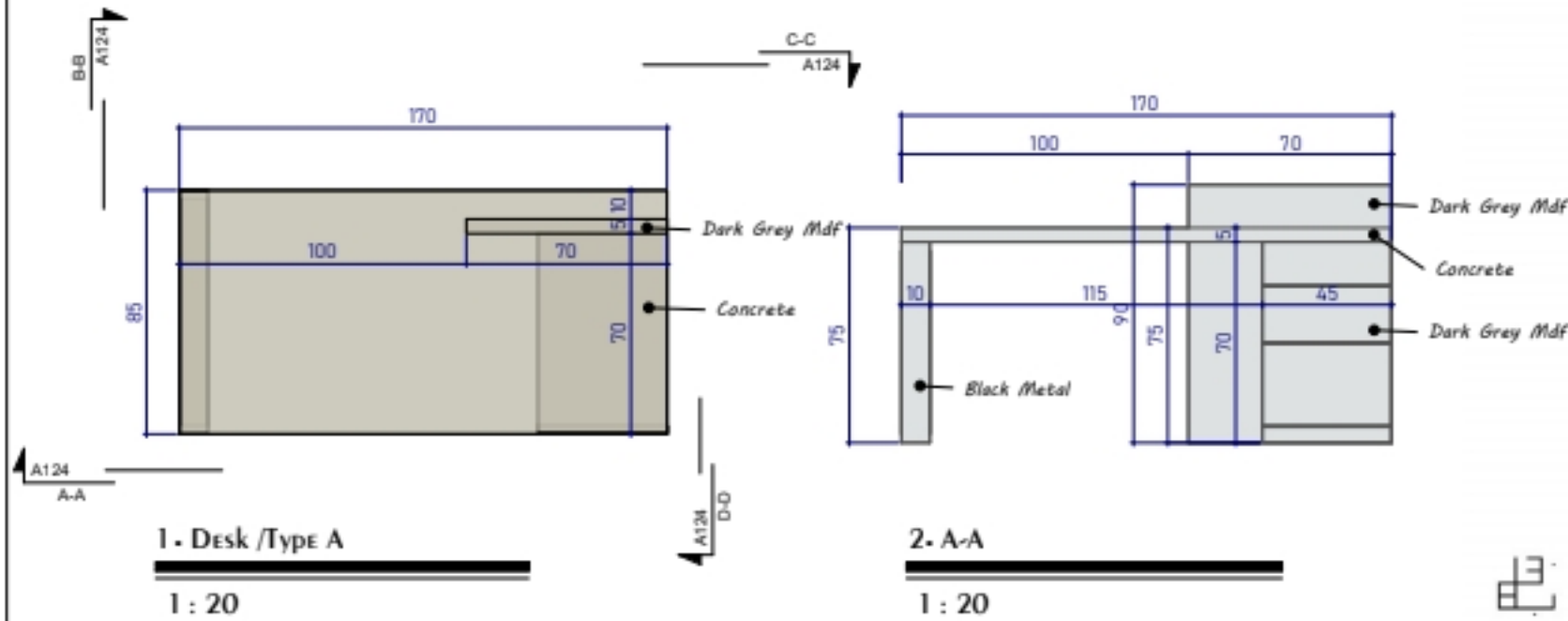

N: 1

PROJECT NAME : PAYARAVANKARAN Office

CLIENT : **PAYA RAVANKARAN ALBORZ**

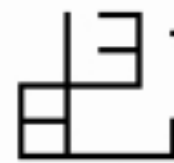

ARCHITECT : MAHSA RAHMATI

ABSAB ARCHITECTURAL DESIGN & CONSTRUCTION TEAM

Desk Type A

Project number

Date

Drawn by

Paper Size :

Issue Date

A124

Scale

No.	Description	Date

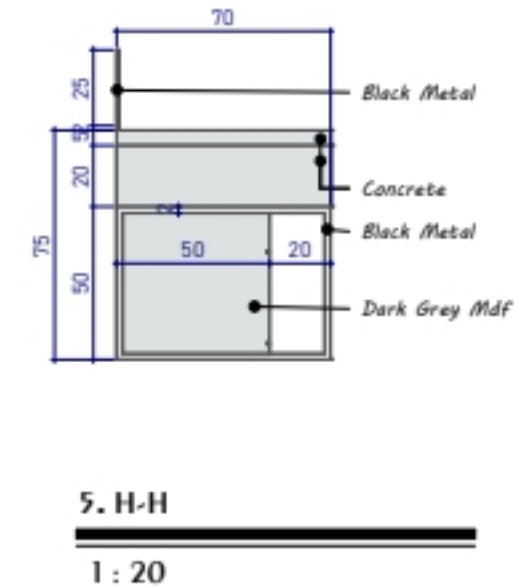
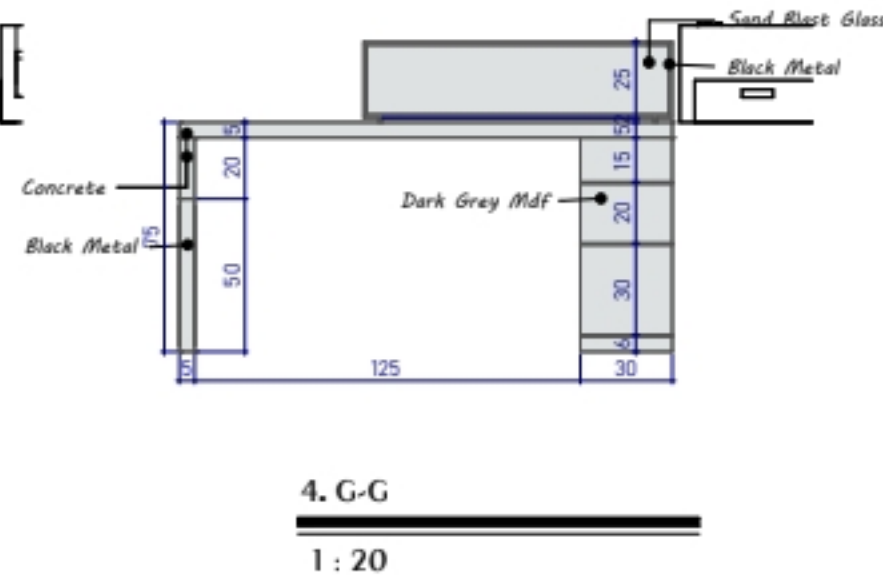
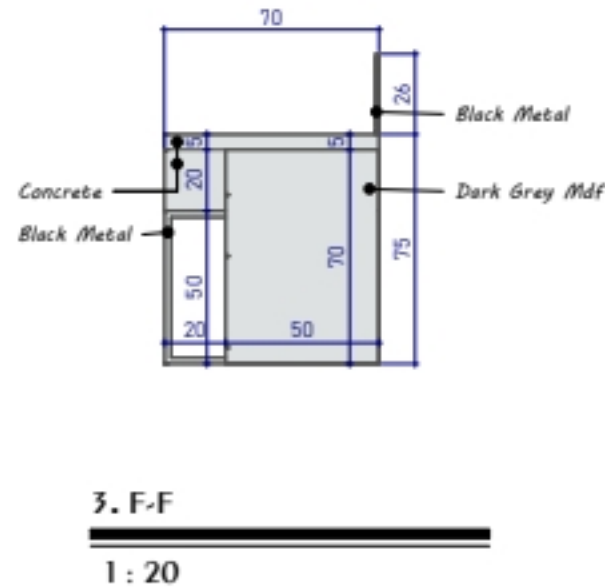
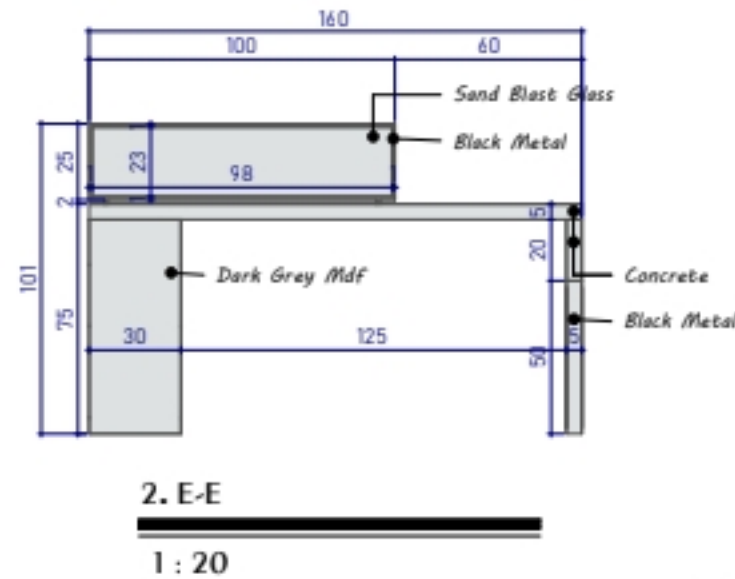
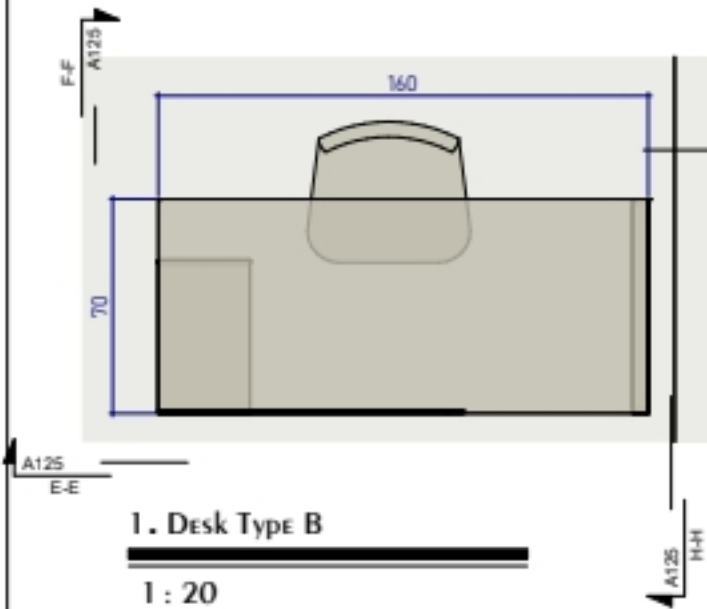

N: 14

PROJECT NAME : PAYARAVANKARAN Office

CLIENT : **PAYA RAVANKARAN ALBORZ**

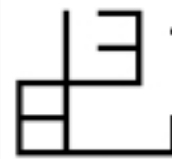

ARCHITECT : MAHSA RAHMATI

ABSAB ARCHITECTURAL DESIGN & CONSTRUCTION TEAM

Desk Type B

Project number

Date

Drawn by

Paper Size :

Issue Date

A125

Scale

No.	Description	Date

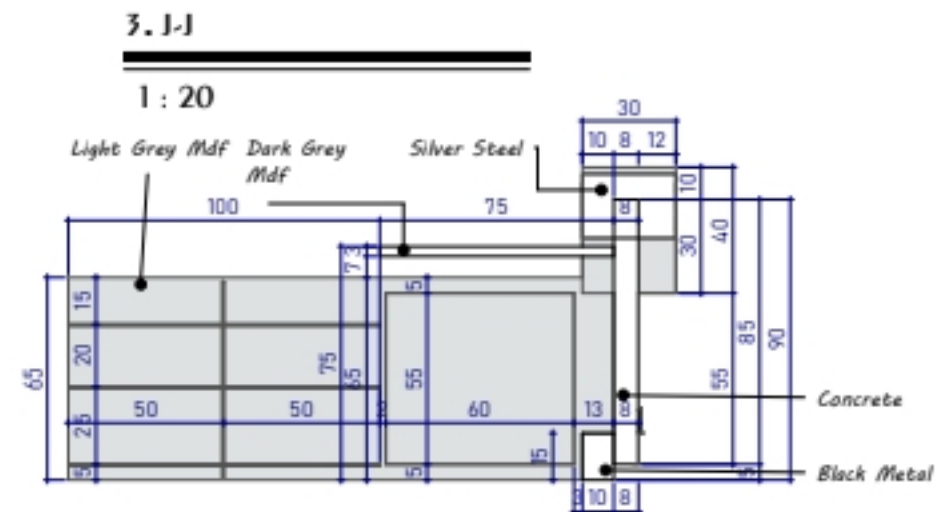
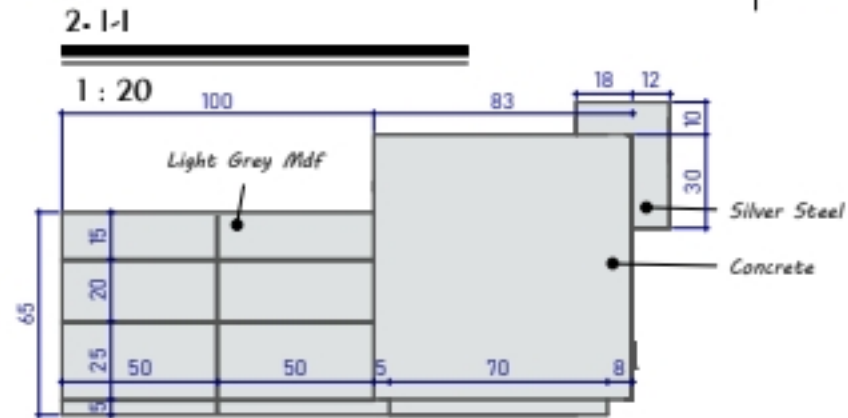
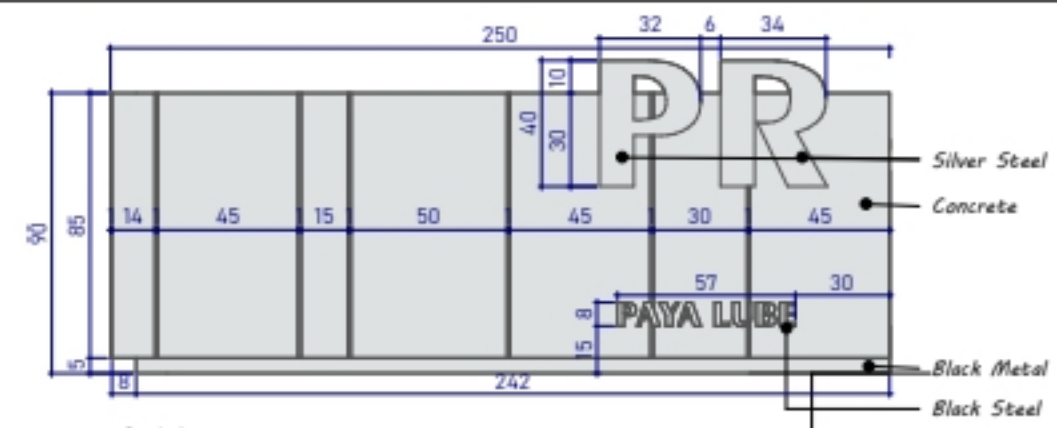
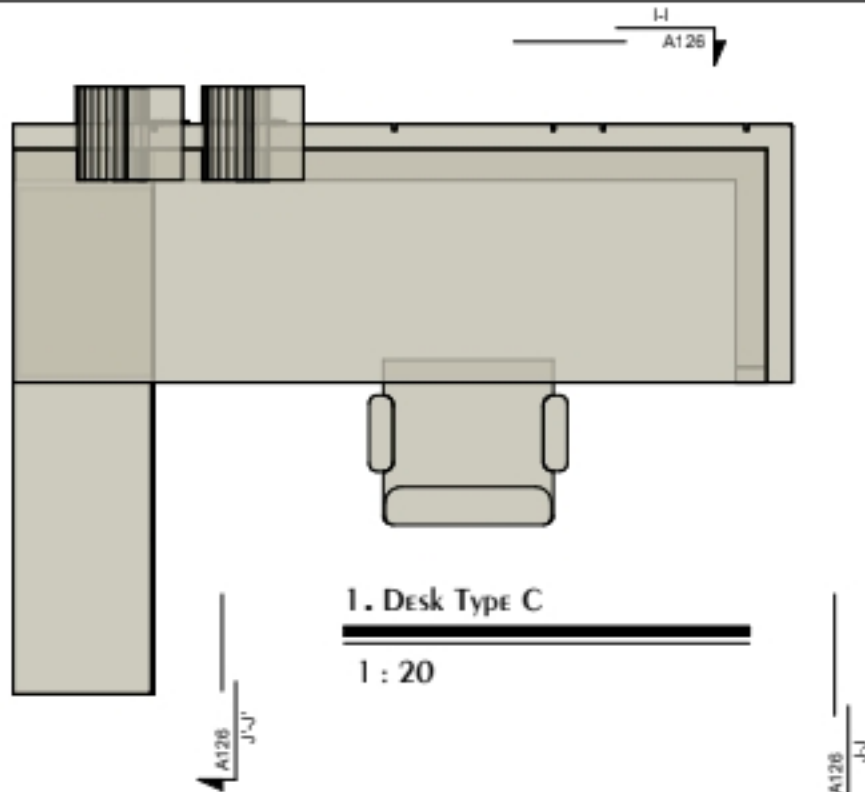

N : 1

PROJECT NAME : PAYARAVANKARAN Office

CLIENT : **PAYA RAVANKARAN ALBORZ**

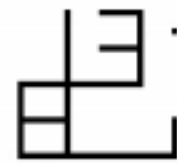

ARCHITECT : MAHSA RAHMATI

ABSAB ARCHITECTURAL DESIGN & CONSTRUCTION TEAM

Desk Type C

Project number
Date Issue Date
Drawn by
Paper Size : A3 Scale

A126

No.	Description	Date

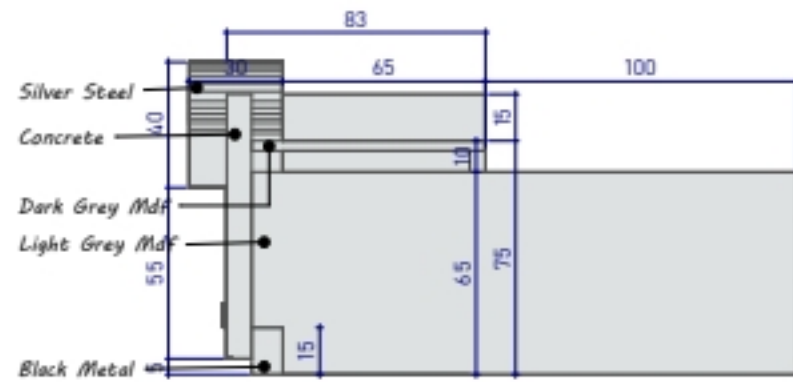

1. K-K

1 : 20

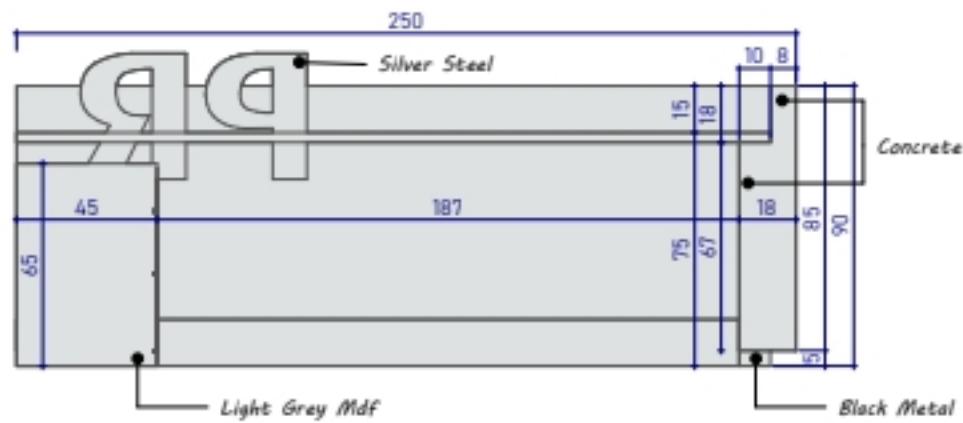

2. L-L

1 : 20

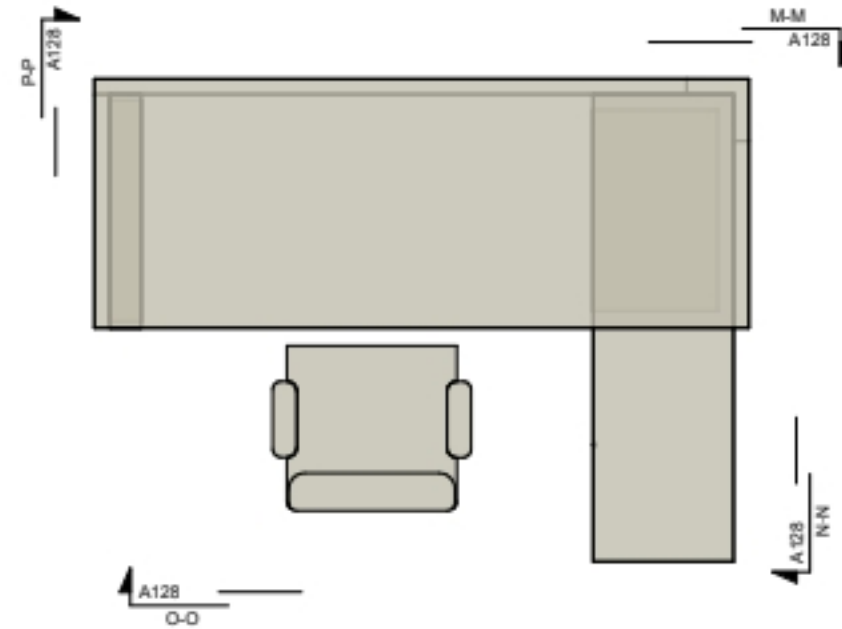

3. Desk Type D

1 : 20



N : 2

PROJECT NAME : PAYARAVANKARAN Office

CLIENT : **PAYA RAVANKARAN ALBORZ**

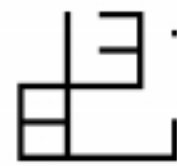

ARCHITECT : MAHSA RAHMATI

ABSAB ARCHITECTURAL DESIGN & CONSTRUCTION TEAM

Desk Type C & D

Project number	A127
Date	
Drawn by	
Paper Size : A3	Scale

No.	Description	Date

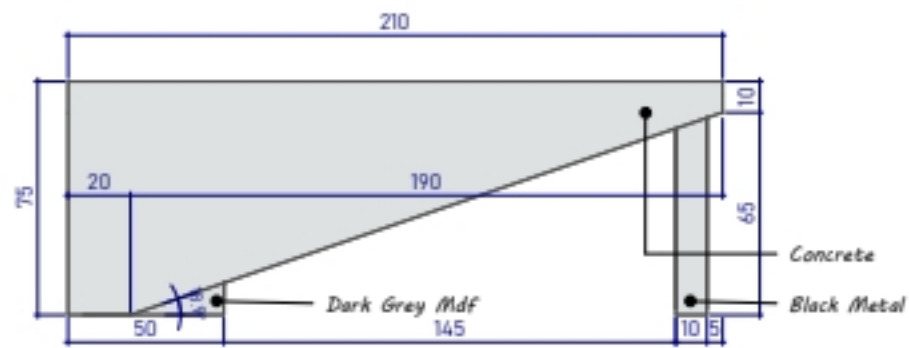

1. M-M
1 : 20

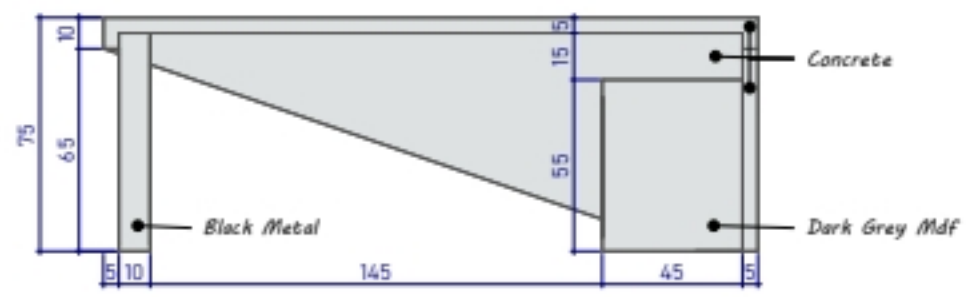

3. O-O
1 : 20

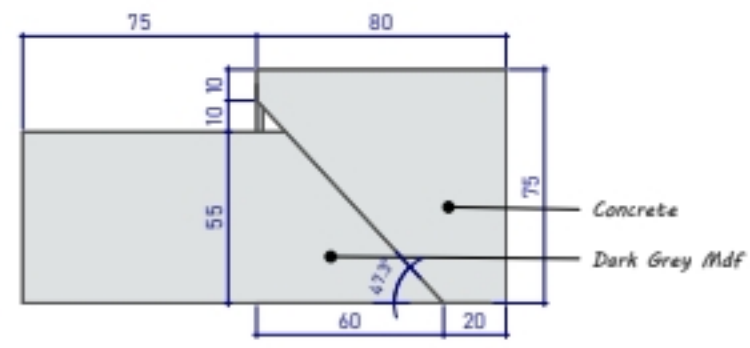

2. N-N
1 : 20

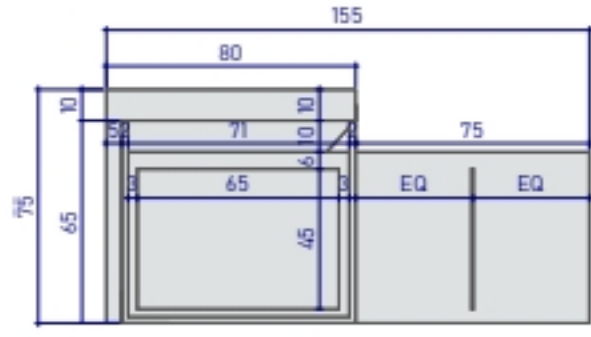

4. P-P
1 : 20

PROJECT NAME : PAYARAVANKARAN Office
CLIENT : **PAYA RAVANKARAN ALBORZ**

ARCHITECT : MAHSA RAHMATI
ABSAB ARCHITECTURAL DESIGN & CONSTRUCTION TEAM

Desk Type D
Project number
Date Issue Date
Drawn by
Paper Size : A3 Scale

No.	Description	Date

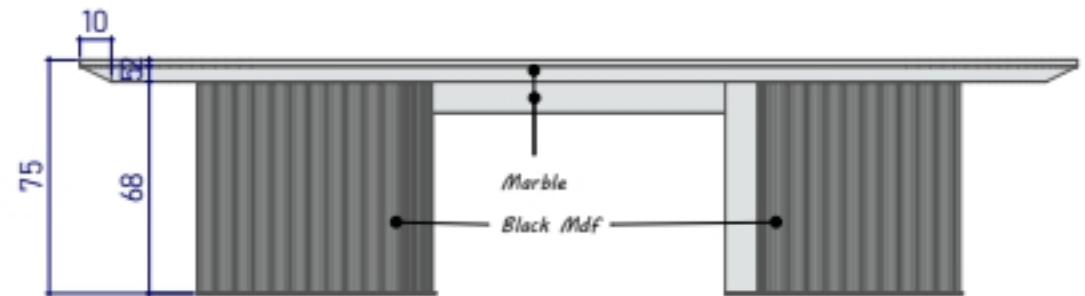
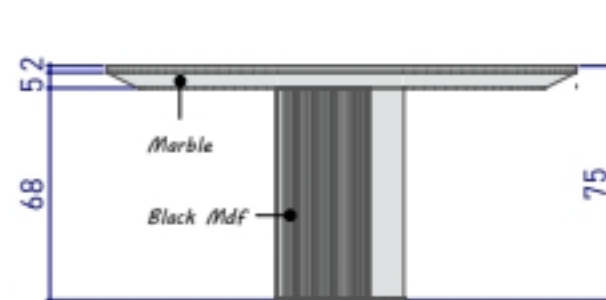
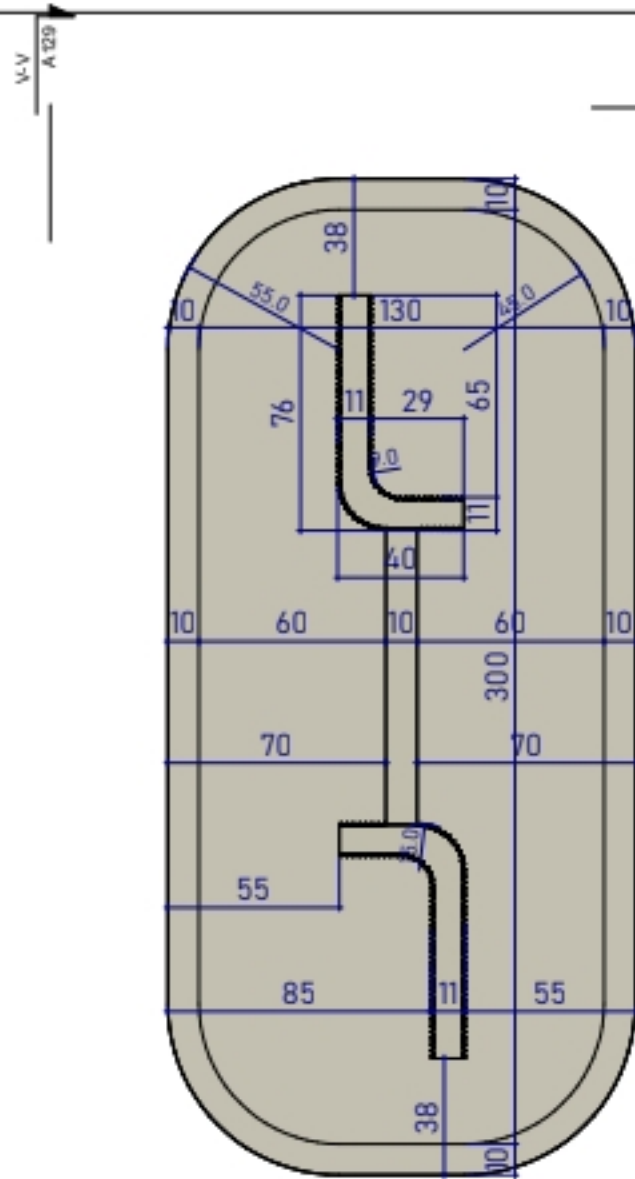

1. Table Type A

1 : 20

3. T-T

1 : 20

2. V-V

1 : 20

N : 1

PROJECT NAME : PAYARAVANKARAN Office

CLIENT : **PAYA RAVANKARAN ALBORZ**

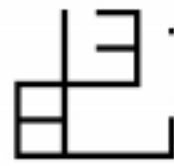

ARCHITECT : MAHSA RAHMATI

ABSAB ARCHITECTURAL DESIGN & CONSTRUCTION TEAM

Table Type A

Project number	A129
Date	
Drawn by	
Issue Date	
Scale	A3

No.	Description	Date



1. Table Type B

1 : 50

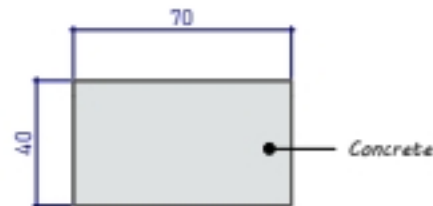

2. O-O

1 : 20

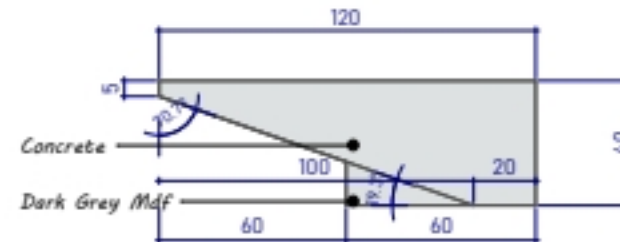

3. R-R

1 : 20

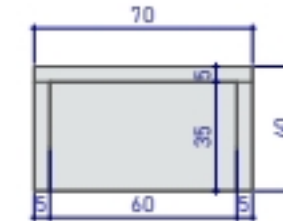

4. S-S

1 : 20

N : 2

PROJECT NAME : PAYARAVANKARAN Office

CLIENT : **PAYA RAVANKARAN ALBORZ**

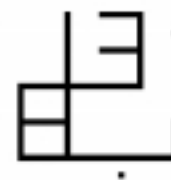

ARCHITECT : MAHSA RAHMATI

ABSAB ARCHITECTURAL DESIGN & CONSTRUCTION TEAM

Table Type B

Project number

Date

Drawn by

Paper Size :

Issue Date

A130

Scale

No.	Description	Date

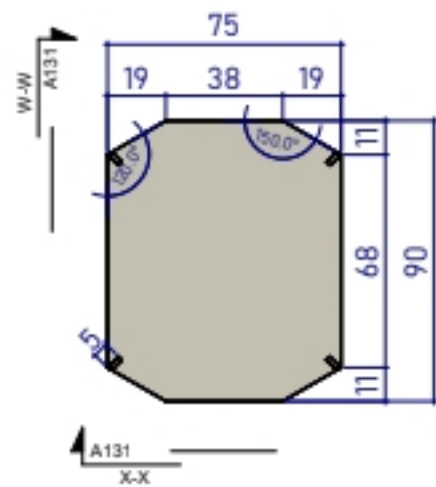

1. Table Type C

1 : 20

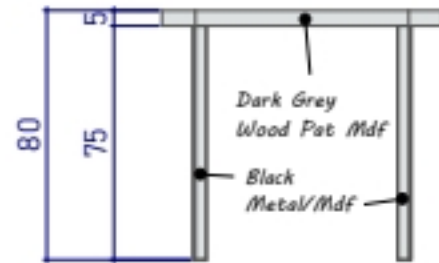

2. W-W

1 : 20

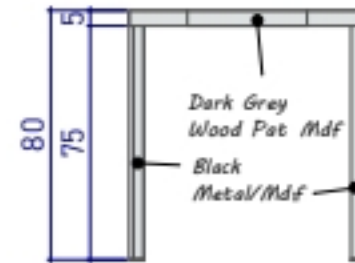

3. X-X

1 : 20

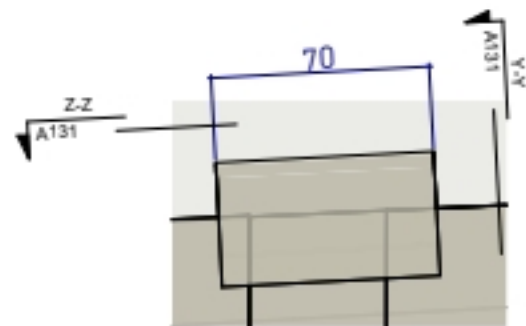

4. Table Type D

1 : 20



5. Y-Y

1 : 20

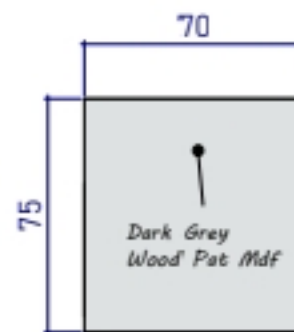

6. Z-Z

1 : 20



PROJECT NAME : PAYARAVANKARAN Office

CLIENT : **PAYA RAVANKARAN ALBORZ**

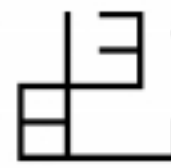

ARCHITECT : MAHSA RAHMATI

ABSAB ARCHITECTURAL DESIGN & CONSTRUCTION TEAM

Table Type C & D

Project number
Date Issue Date
Drawn by
Paper Size : A3

A131

Scale

No.	Description	Date

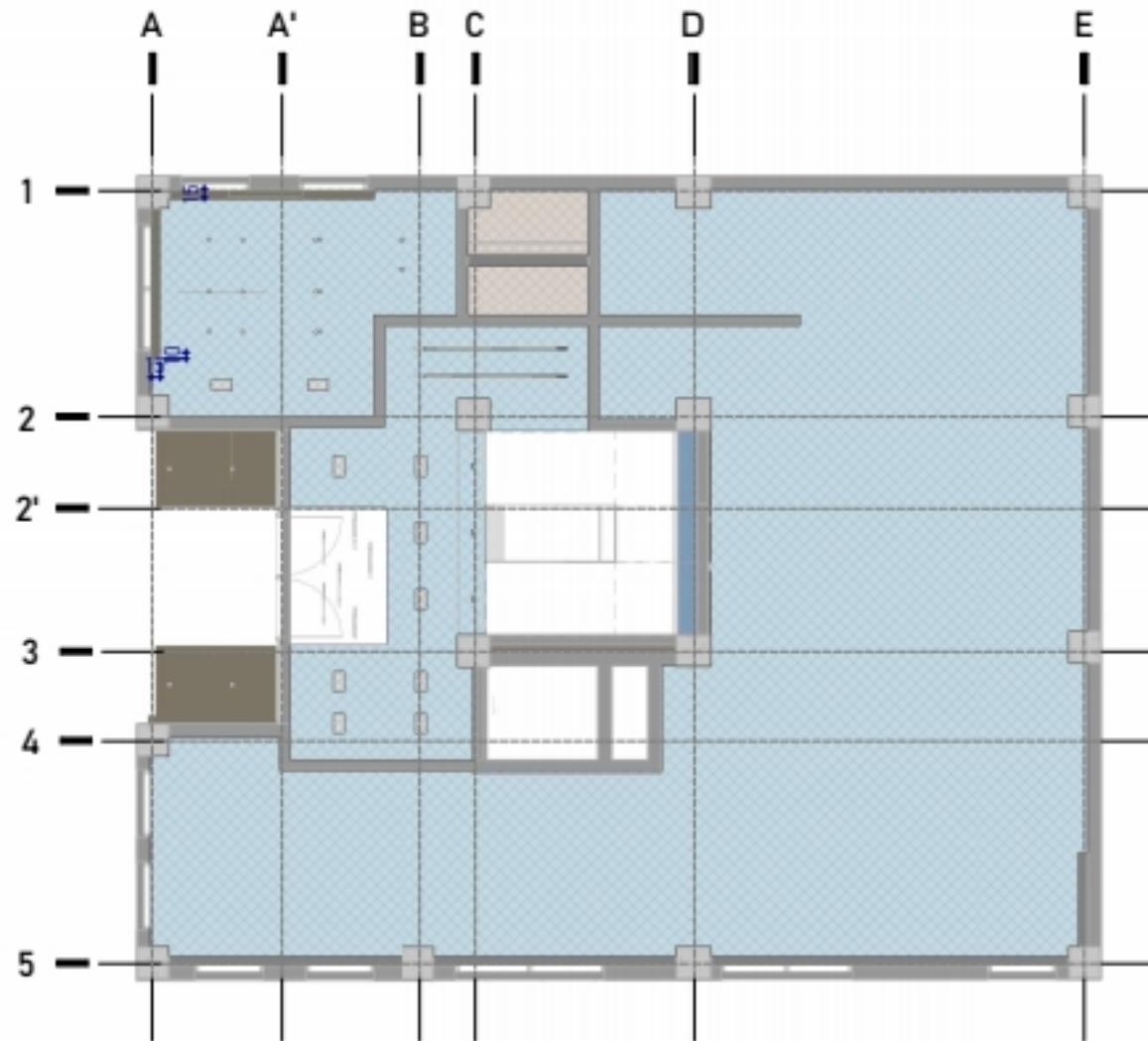

1. GROUND FLOOR-CEILING PLAN

1 : 100

Ceiling Legend	
Kensuf_R6_H:3-00 m White	
Kensuf_R6_H:2-60 m White	
Kensuf_R6_H:2-60 m Green	
Kensuf_MR_H:2-60 m White	
Stretch_Metal_H:2-60 m Black	
Stretch_Metal_H:2-60 m Green	
Termo_Wood_H:3-00 m	

PROJECT NAME : PAYARAVANKARAN Office

CLIENT : **PAYA RAVANKARAN ALBORZ**

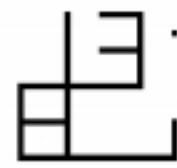

ARCHITECT : MAHSA RAHMATI

ABSAB ARCHITECTURAL DESIGN & CONSTRUCTION TEAM

GROUND FLOOR CEILING PLAN

Project number
Date Issue Date
Drawn by
Paper Size : A3

A132

Scale

No.	Description	Date

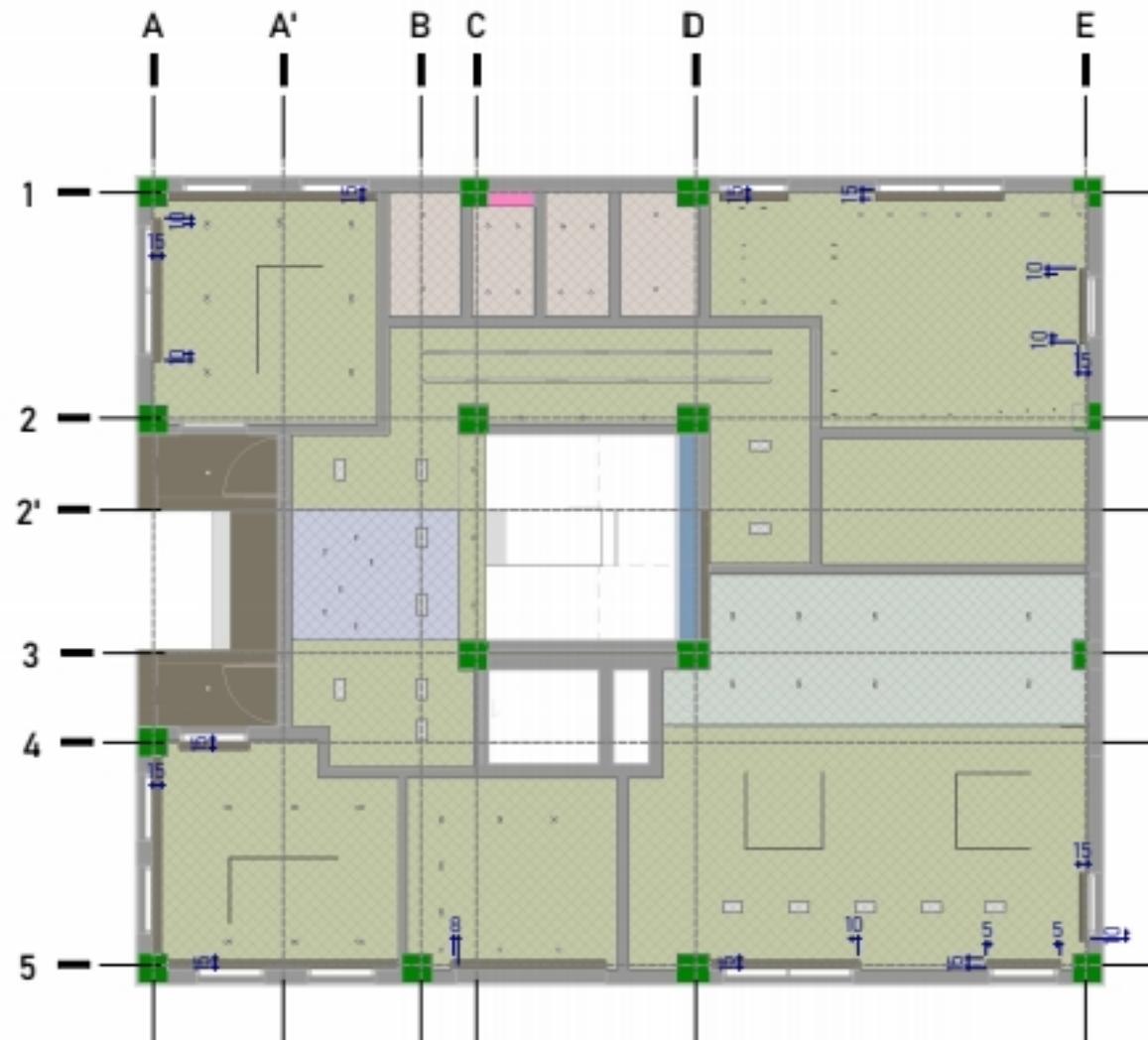

1. 1st FLOOR--CEILING PLAN

1 : 100

Ceiling Legend	
<i>Kenaul_R6_H:3-00 m</i> <i>White</i>	
<i>Kenaul_R6_H:2-60 m</i> <i>White</i>	
<i>Kenaul_R6_H:2-60 m</i> <i>Green</i>	
<i>Kenaul_MR_H:2-60 m</i> <i>White</i>	
<i>Stretch_Metal_H:2-60 m</i> <i>Black</i>	
<i>Stretch_Metal_H:2-60 m</i> <i>Green</i>	
<i>Termo_Wood_H:3-00 m</i>	

PROJECT NAME : PAYARAVANKARAN Office

CLIENT : **PAYA RAVANKARAN ALBORZ**

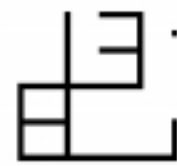

ARCHITECT : MAHSA RAHMATI

ABSAB ARCHITECTURAL DESIGN & CONSTRUCTION TEAM

FIRST CEILING PLAN

Project number

Date

Drawn by

Paper Size :

Issue Date

A133

Scale

No.	Description	Date

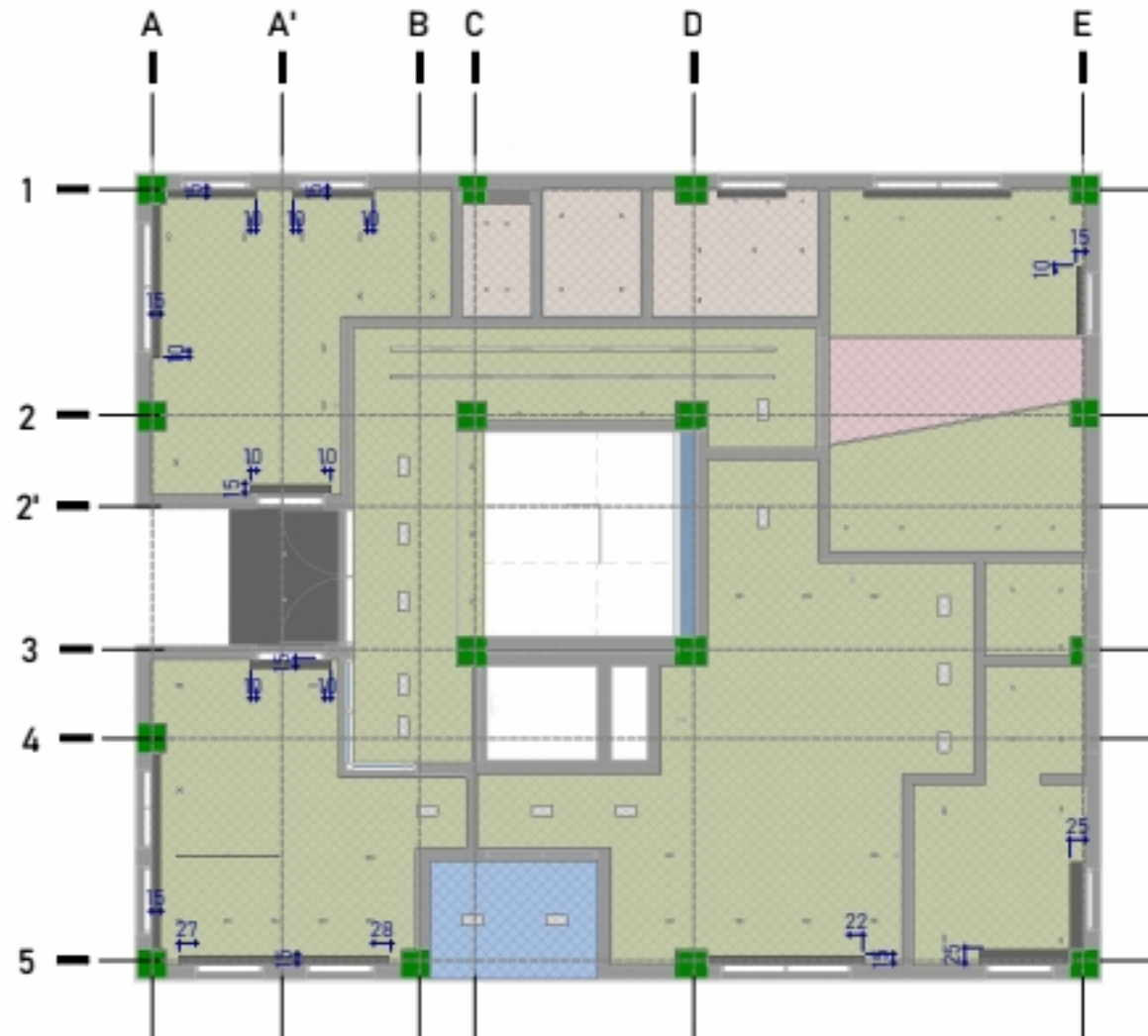

1. 2nd Floor-Ceiling PLAN

1 : 100

Ceiling Legend	
Kanouf_RG_H:3-00 m White	
Kanouf_RG_H:2-60 m White	
Kanouf_RG_H:2-60 m Green	
Kanouf_MR_H:2-60 m White	
Stretch Metal_H:2-60 m Black	
Stretch Metal_H:2-60 m Green	
Termo Wood_H:3-00 m	

PROJECT NAME : PAYARAVANKARAN Office

CLIENT : **PAYA RAVANKARAN ALBORZ**

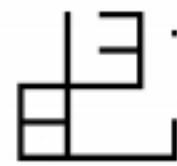

ARCHITECT : MAHSA RAHMATI

ABSAB ARCHITECTURAL DESIGN & CONSTRUCTION TEAM

SECOND CEILING PLAN

Project number
Date Issue Date
Drawn by
Paper Size : A3

AI34

Scale

No.	Description	Date

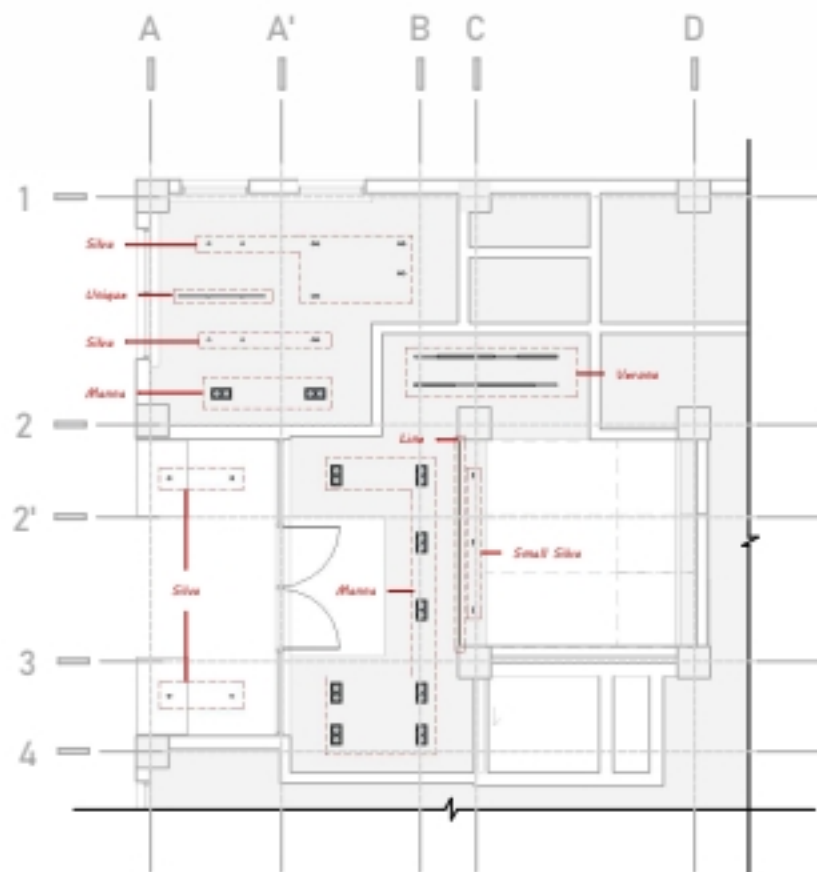

1. G.F Ceiling Lighting PLAN

1 : 100

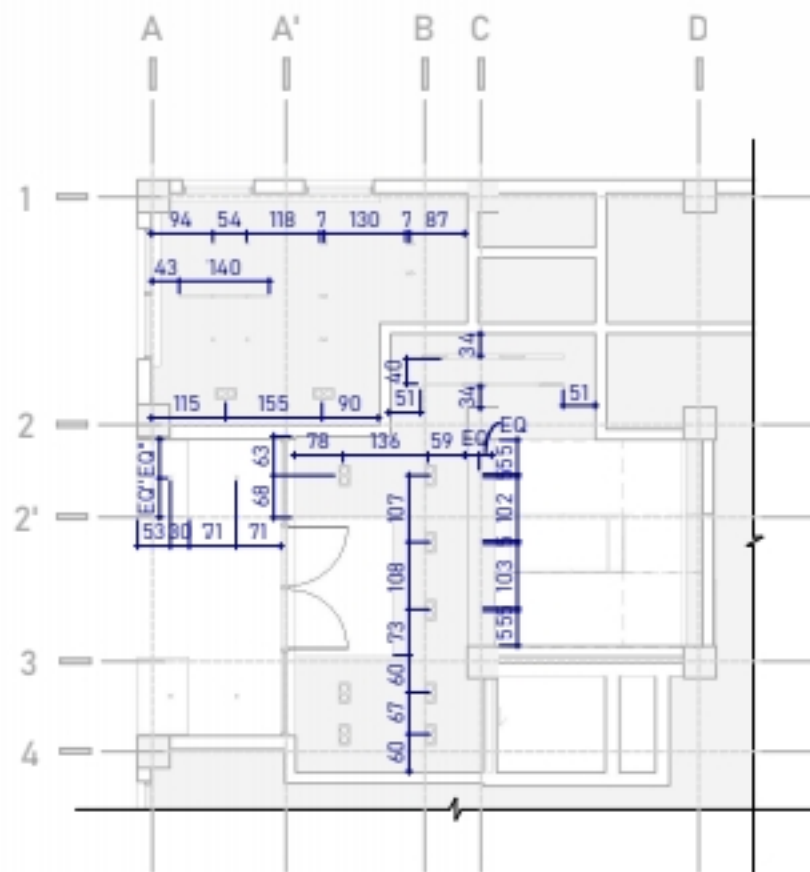

2. G.F Ceiling Lighting DIM PLAN

1 : 100

Lighting Legend	
Spot Unique Multi Tarck System	
Verona Multi Tarck System	
Manna	
Silva Spot	
Dream	
Line Pendant	
Line-Wall Line- Ground Line	

** کلیه فواصل از آکس روشنایی ها می باشد.

PROJECT NAME : PAYARAVANKARAN Office

CLIENT : **PAYA RAVANKARAN ALBORZ**

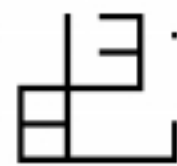

ARCHITECT : MAHSA RAHMATI

ABSAB ARCHITECTURAL DESIGN & CONSTRUCTION TEAM

G.F Ceiling Lighting&DIM PLAN

Project number

Date

Drawn by

Paper Size :

Issue Date

Scale

A135

No.	Description	Date

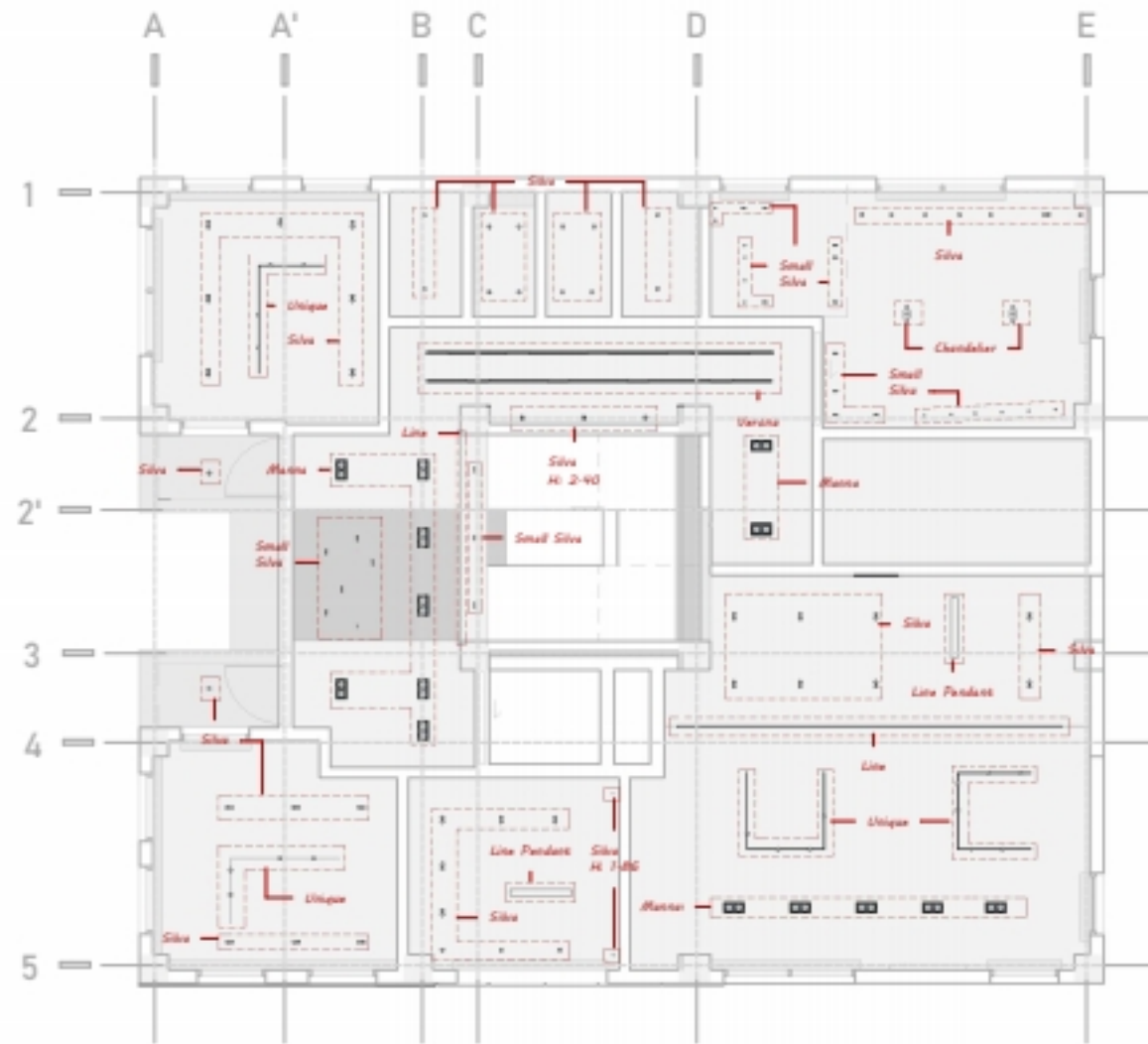

1. FIRST CEILING LIGHTING PLAN

1 : 100

Lighting Legend	
Spot Unique Multi Tarck System	
Verona Multi Tarck System	
Manna	
Silva Spot	
Dream	
Line Pendant	
Line-Wall Line- Ground Line	

PROJECT NAME : PAYARAVANKARAN Office

CLIENT : **PAYA RAVANKARAN ALBORZ**

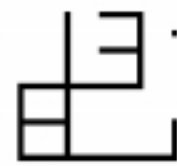

ARCHITECT : MAHSA RAHMATI

ABSAB ARCHITECTURAL DESIGN & CONSTRUCTION TEAM

FIRST CEILING LIGHTING PLAN

Project number

Date

Drawn by

Paper Size : A3

Issue Date

A136

Scale

No.	Description	Date

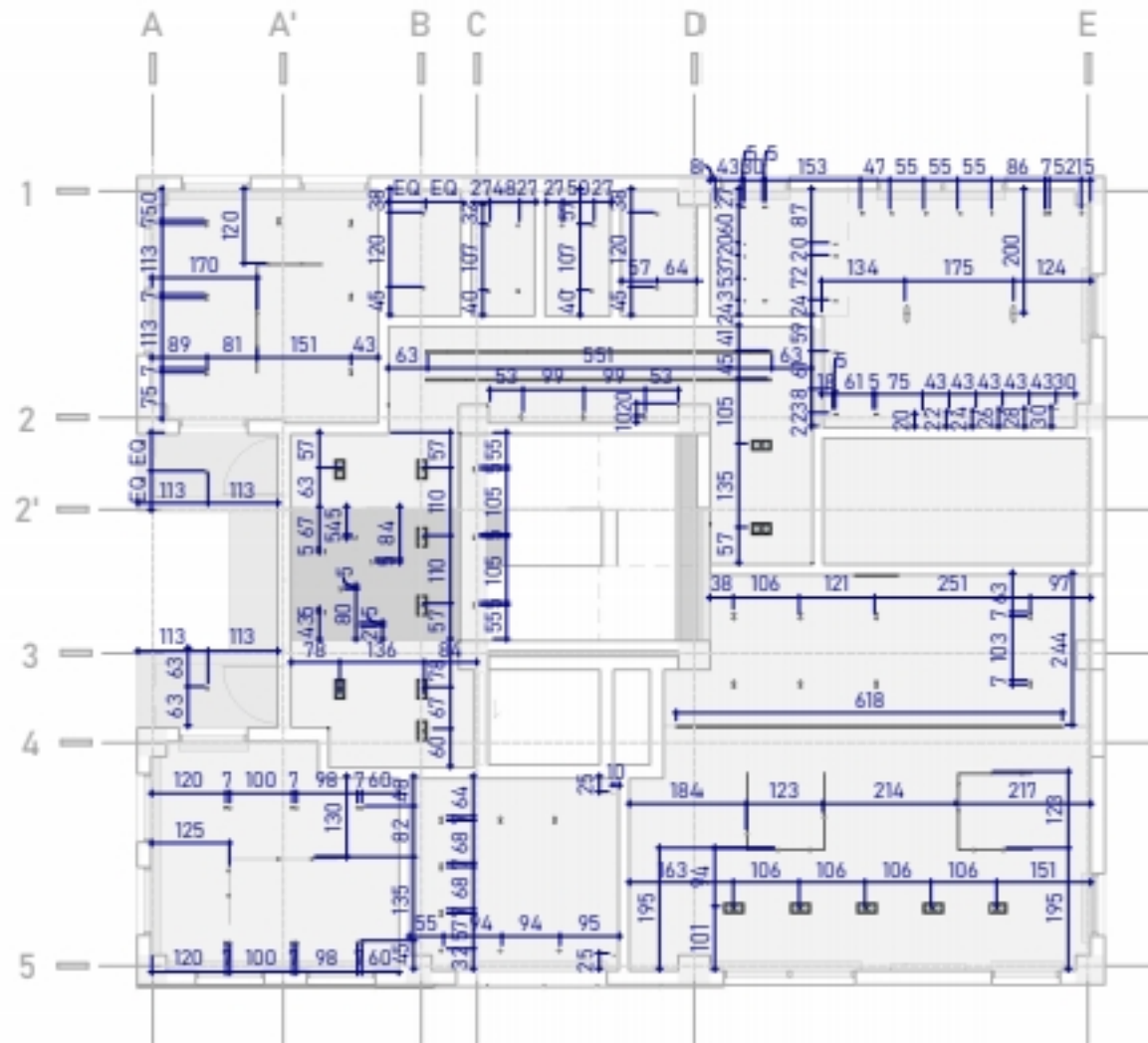

1. FIRST CEILING LIGHTING DIM PLAN

1 : 100

** کلیه فواصل از آکس روشنایی ها می باشد.

PROJECT NAME : PAYARAVANKARAN Office

CLIENT : **PAYA RAVANKARAN ALBORZ**

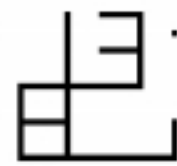

ARCHITECT : MAHSA RAHMATI

ABSAB ARCHITECTURAL DESIGN & CONSTRUCTION TEAM

FIRST CEILING DIM PLAN

Project number

Date

Drawn by

Paper Size :

Issue Date

A137

Scale

No.	Description	Date



Lighting Legend	
Spot Unique Multi Tarck System	
Verona Multi Tarck System	
Manna	
Silva Spot	
Dream	
Line Pendant	
Line-Wall Line- Ground Line	

1. Second Ceiling Lighting Plan

1 : 100

PROJECT NAME : **PAYARAVANKARAN Office**
 CLIENT : **PAYA RAVANKARAN ALBORZ**

ARCHITECT : **MAHSA RAHMATI**
ABSAB ARCHITECTURAL DESIGN & CONSTRUCTION TEAM

SECOND CEILING LIGHTING PLAN
 Project number: **A138**
 Date: _____ Issue Date: _____
 Drawn by: _____
 Paper Size: A3 Scale: _____

No.	Description	Date

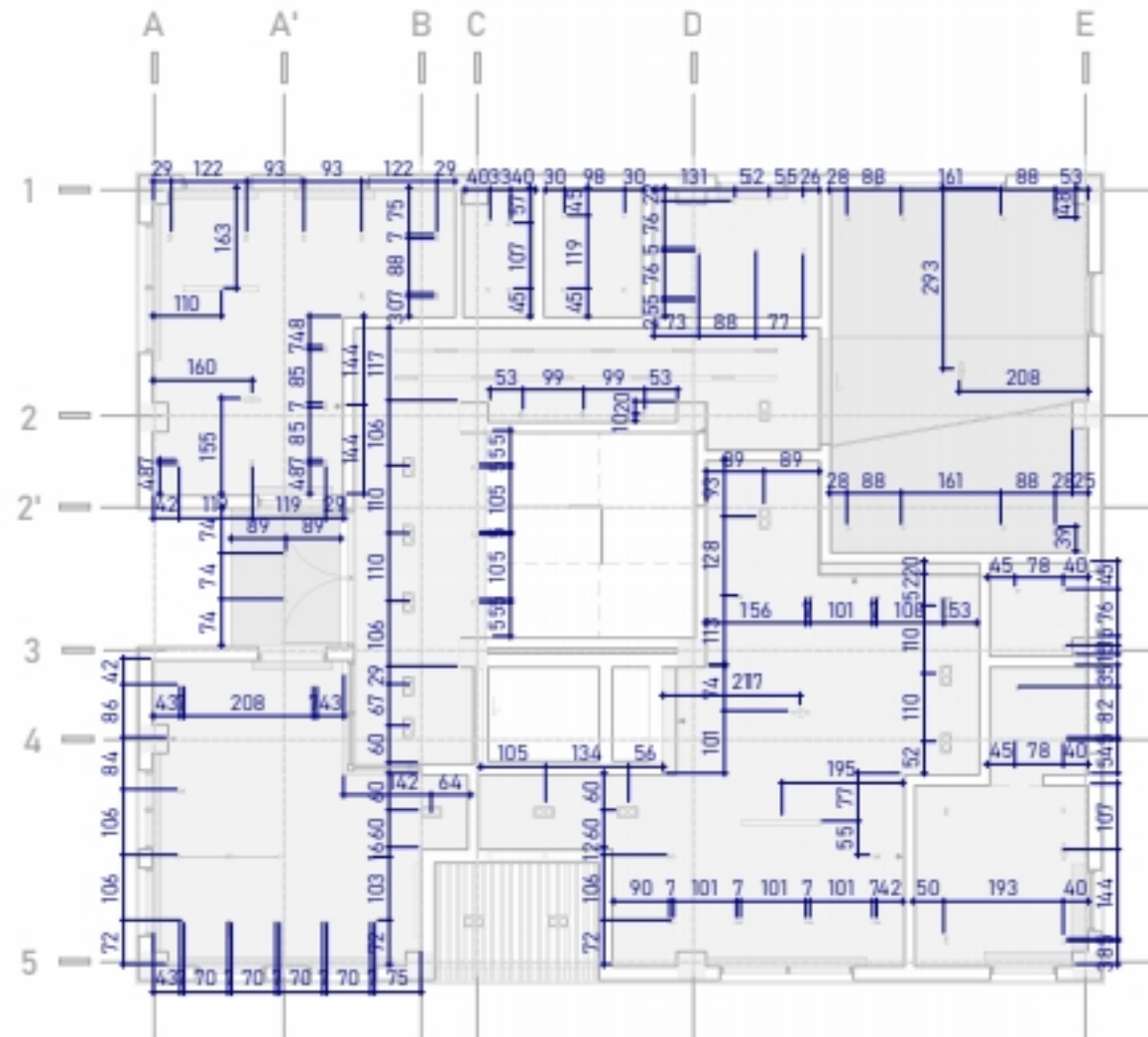

1. Second Ceiling Lighting Dim Plan

1 : 100

** کلیه فواصل از آکس روشنایی ها می باشد.

PROJECT NAME : PAYARAVANKARAN Office

CLIENT : **PAYA RAVANKARAN ALBORZ**

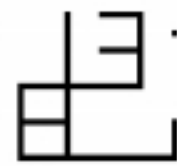

ARCHITECT : MAHSA RAHMATI

ABSAB ARCHITECTURAL DESIGN & CONSTRUCTION TEAM

SECOND CEILING DIM PLAN

Project number

Date Issue Date **A139**

Drawn by

Paper Size : A3 Scale

No.	Description	Date

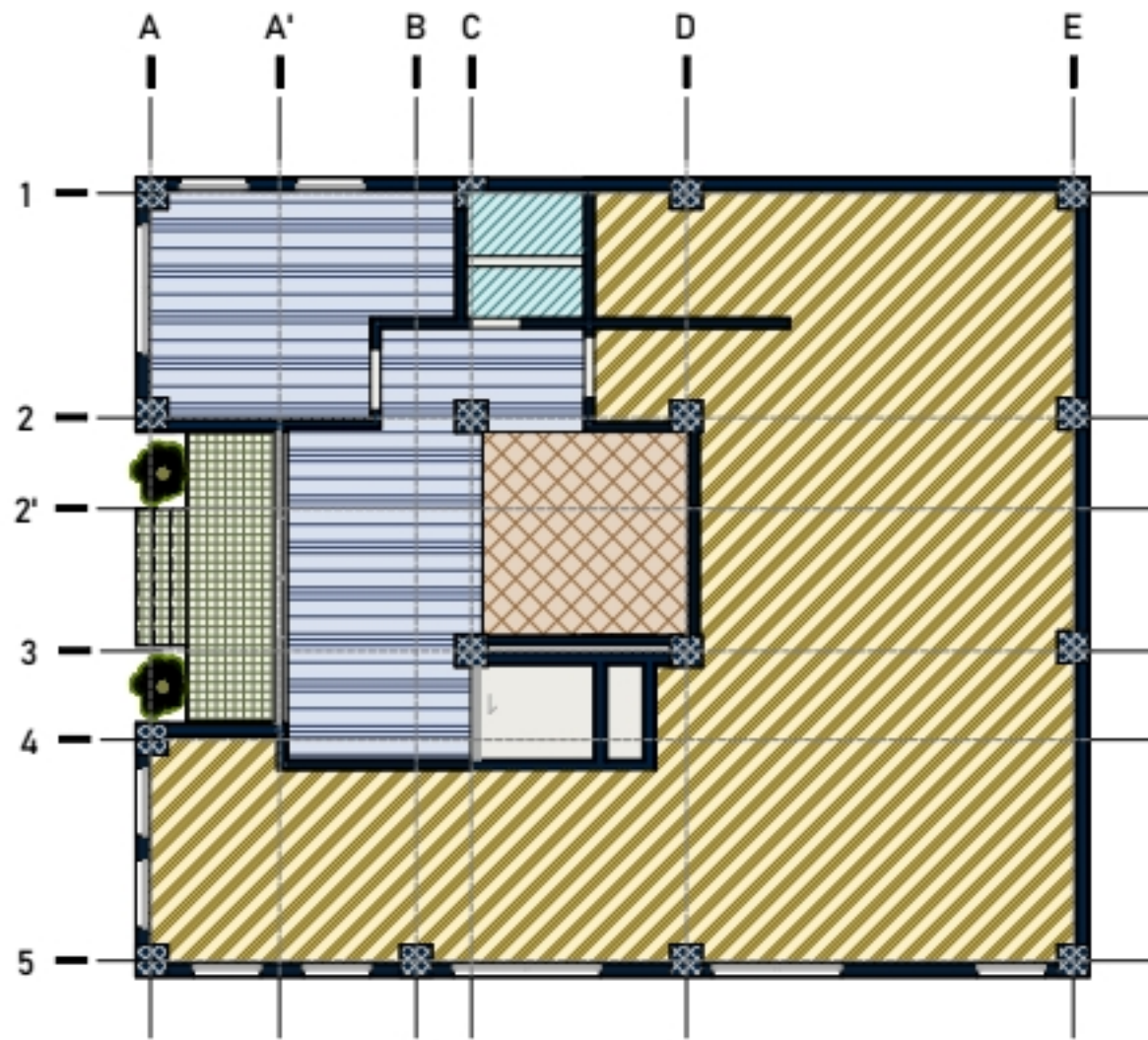

1. GROUND FLOOR-FLOORING PLAN

1 : 100

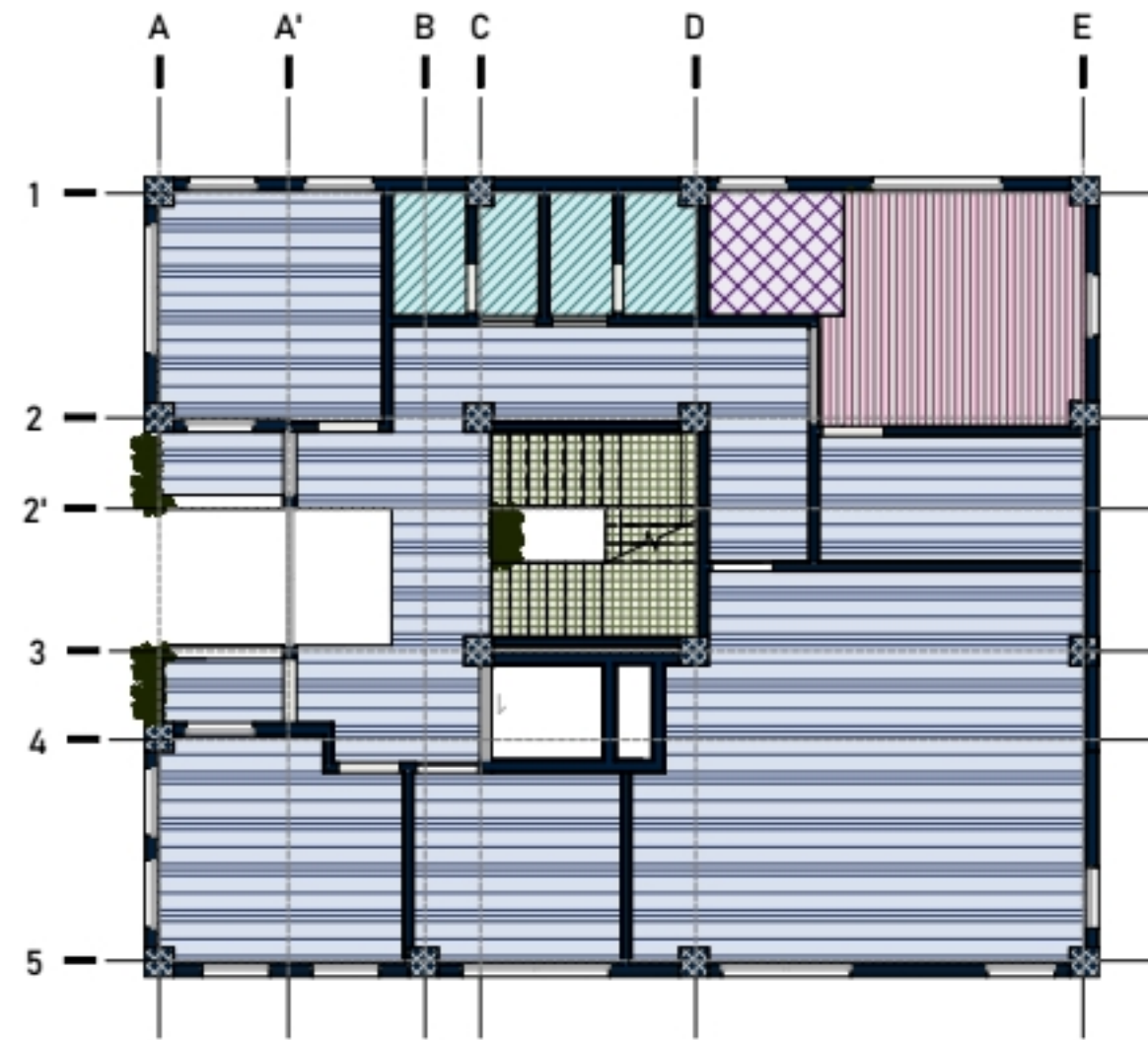

2. 1ST FLOOR_FURNITURE PLAN

1 : 100

Lighting Legend			
Ceramic 120*120 Cm		Termo Wood	
Ceramic 60*120 Cm		Marble Stone	
Concrete		Parquet	
Micro Cement			

PROJECT NAME : PAYARAVANKARAN Office

CLIENT : **PAYA RAVANKARAN ALBORZ**

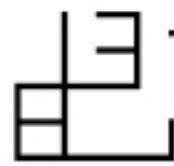

ARCHITECT : MAHSA RAHMATI

ABSAB ARCHITECTURAL DESIGN & CONSTRUCTION TEAM

G.F & 1st FLOORING PLAN

Project number
Date Issue Date
Drawn by
Paper Size : A3 Scale

AI40

No.	Description	Date

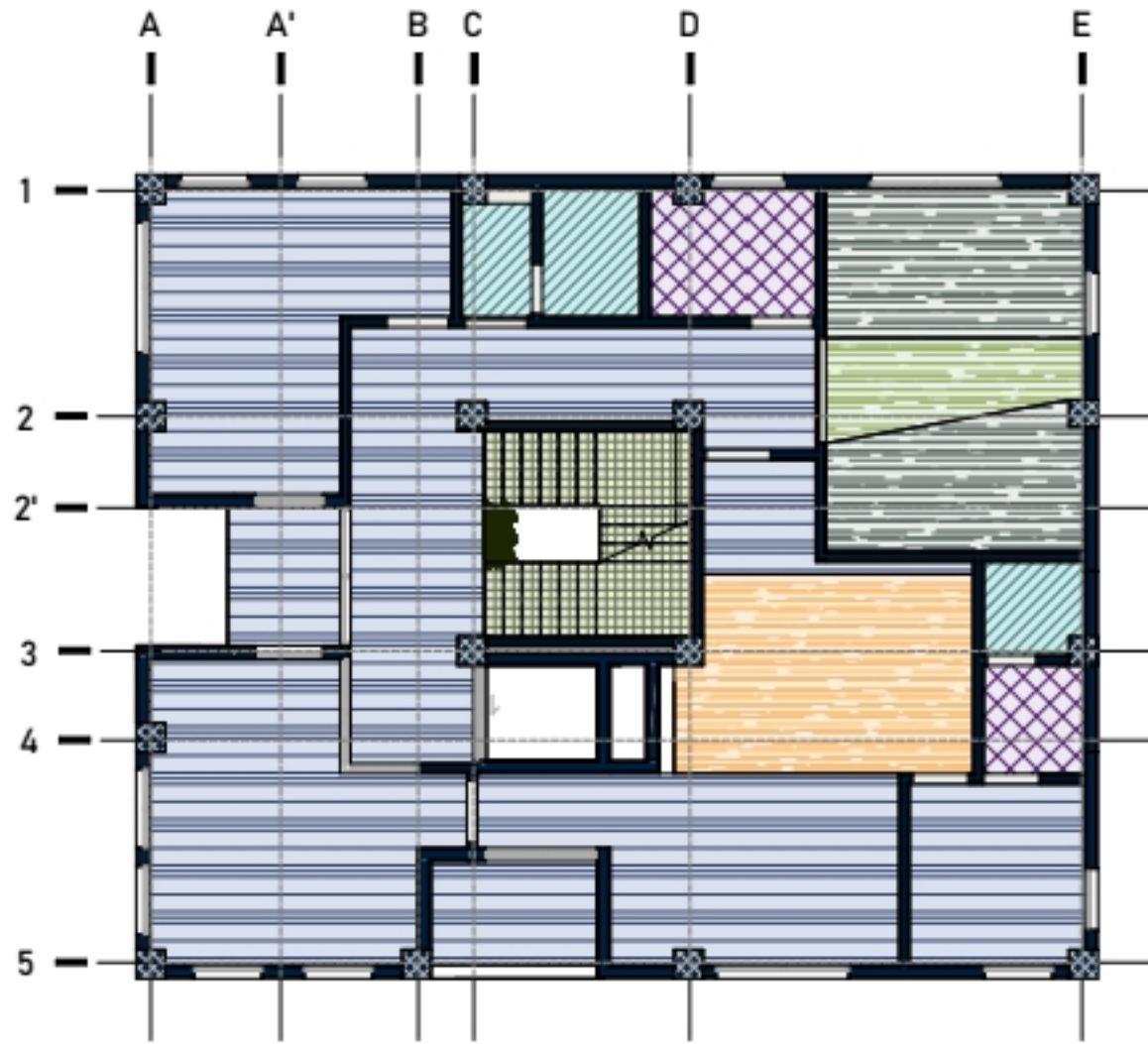

1. 2nd Floor_FLOORING PLAN

1 : 100

Lighting Legend			
Ceramic 120*120 Cm		Termo Wood	
Ceramic 60*120 Cm		Marble Stone	
Concrete		Parquet	
Micro Cement		Carpet	

PROJECT NAME : PAYARAVANKARAN Office

CLIENT : **PAYA RAVANKARAN ALBORZ**

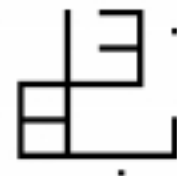

ARCHITECT : MAHSA RAHMATI

ABSAB ARCHITECTURAL DESIGN & CONSTRUCTION TEAM

2nd FLOORING PLAN

Project number
Date Issue Date
Drawn by
Paper Size : A3

A141

Scale

No.	Description	Date

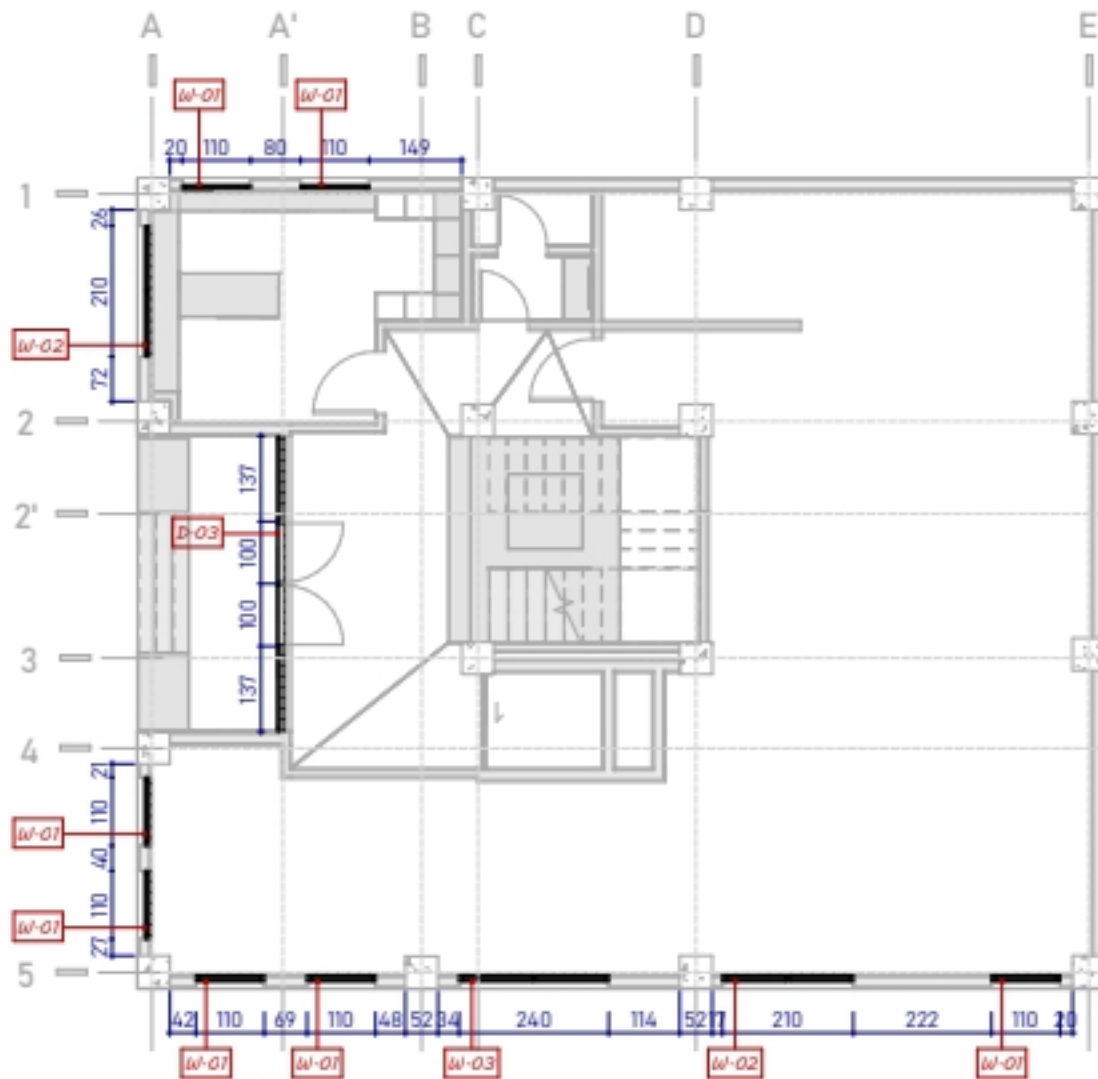

1. Window Dimension Plan-GF

1 : 100

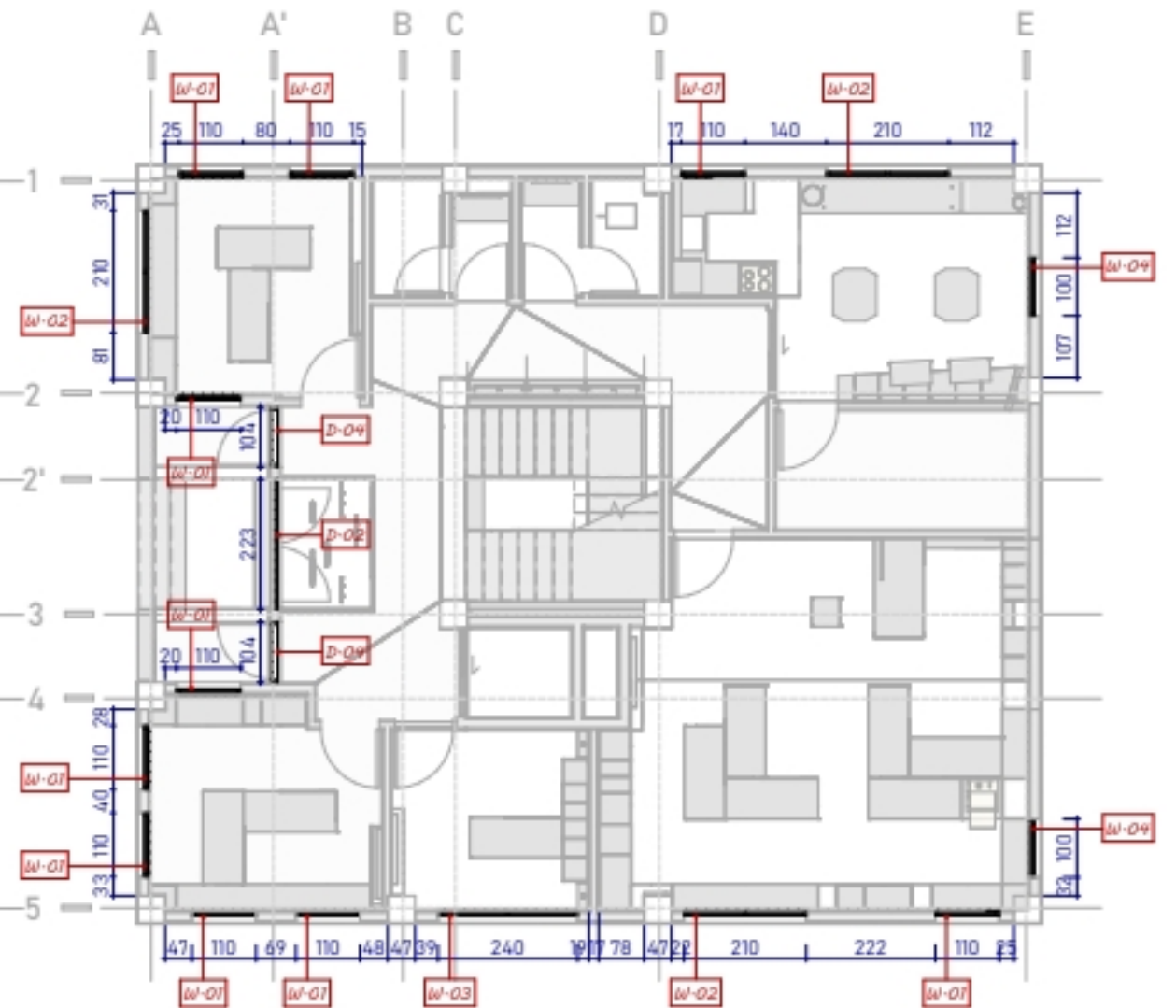

2. Window Dimension Plan _ 1st

1 : 100

PROJECT NAME : PAYARAVANKARAN Office

CLIENT : **PAYA RAVANKARAN ALBORZ**

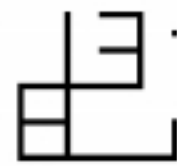

ARCHITECT : MAHSA RAHMATI

ABSAB ARCHITECTURAL DESIGN & CONSTRUCTION TEAM

Window Dimension Plan _ GF & 1st

Project number

Date

Drawn by

Paper Size :

Issue Date

AI42

Scale

No.	Description	Date

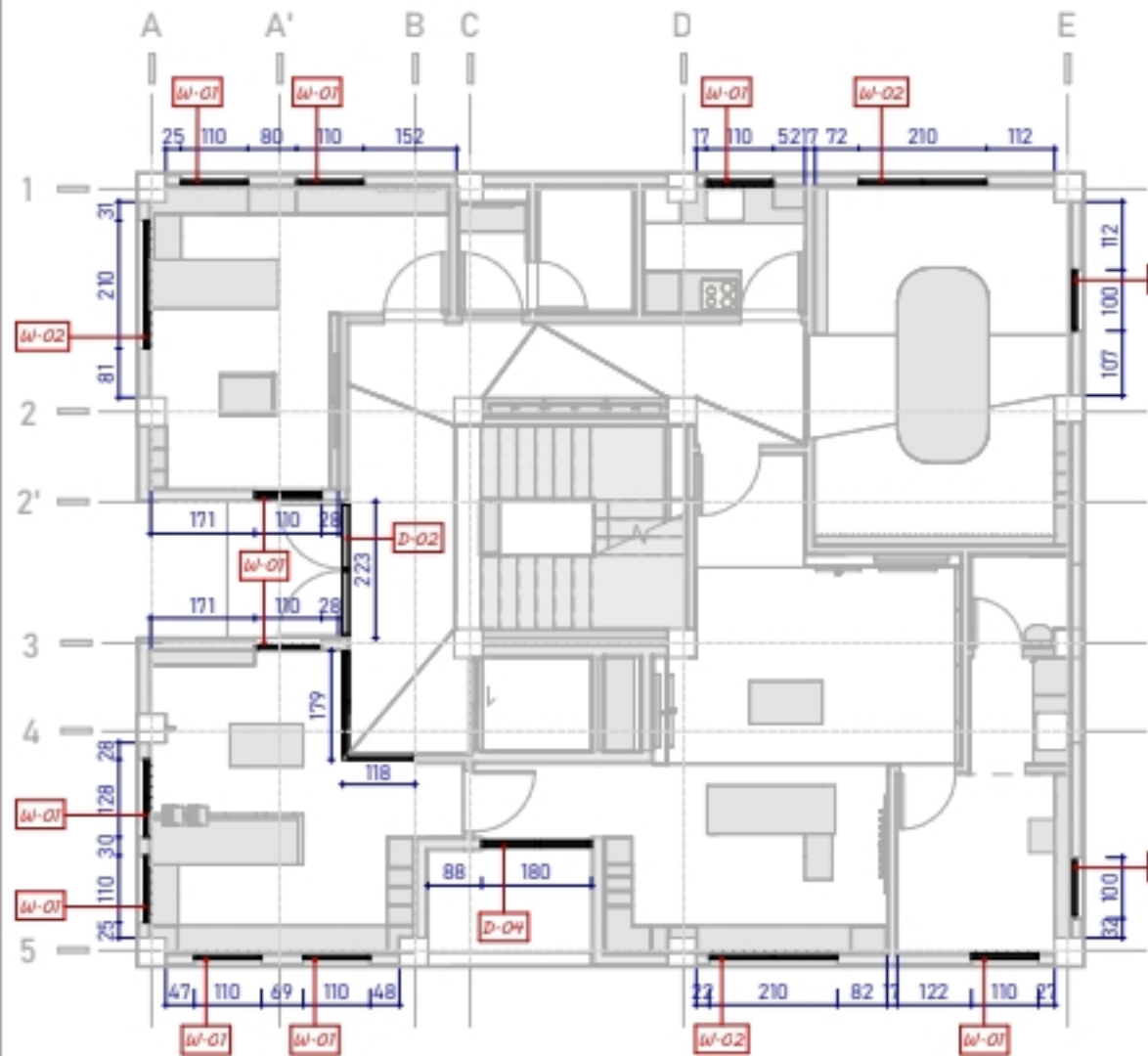

1. Window Dimension Plan _ 2nd
1 : 100

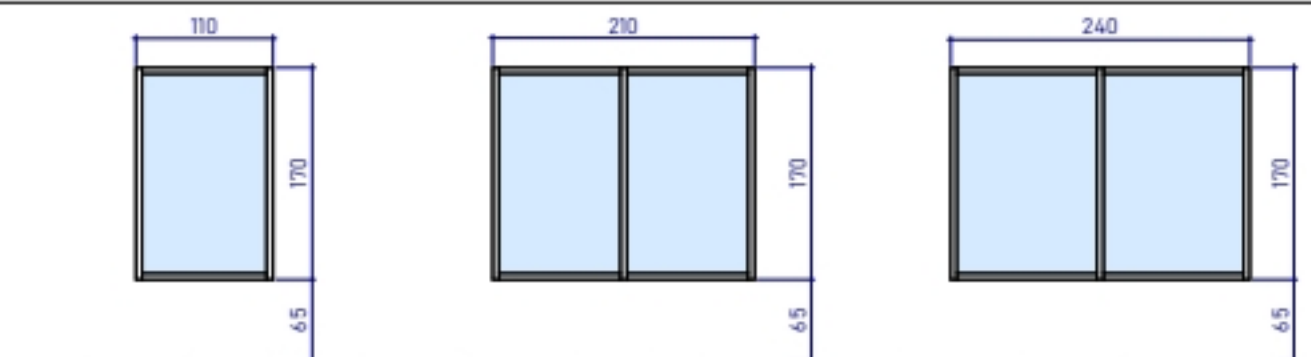

2. Window 01 1 : 50
3. Window 02 1 : 50
4. Window 03 1 : 50

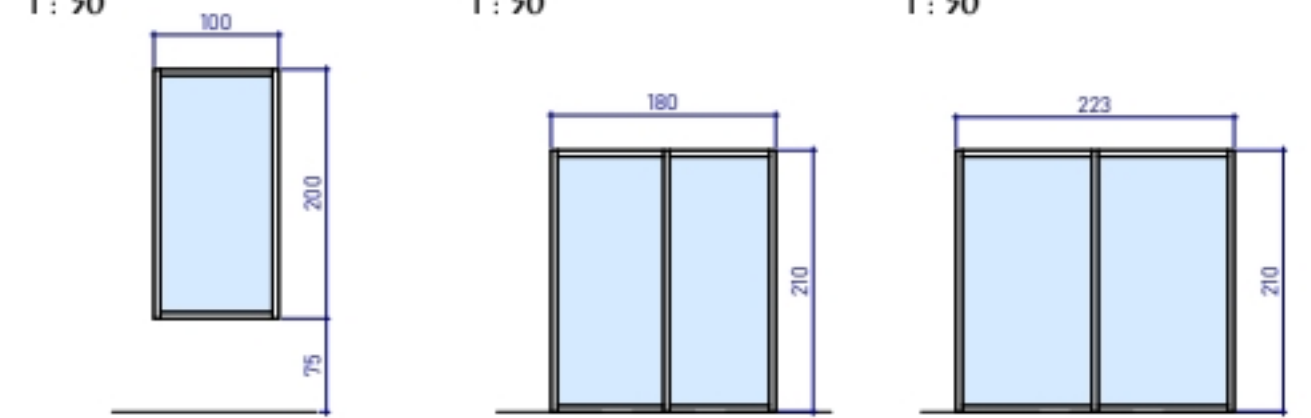

5. Window 04 1 : 50
6. Door 01 1 : 50
7. Door 02 1 : 50

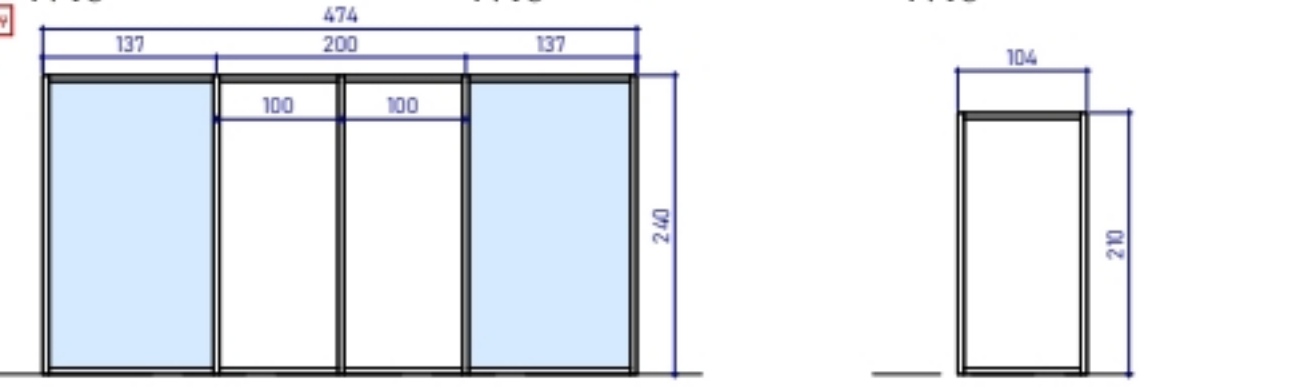

8. Door 03 1 : 50
9. Door 04 1 : 50

PROJECT NAME : PAYARAVANKARAN Office
CLIENT : **PAYA RAVANKARAN ALBORZ**

ARCHITECT : MAHSA RAHMATI
ABSAB ARCHITECTURAL DESIGN & CONSTRUCTION TEAM

Window Dimension Plan _ 2nd
Project number
Date Issue Date
Drawn by
Paper Size : A3 Scale

A143

No.	Description	Date

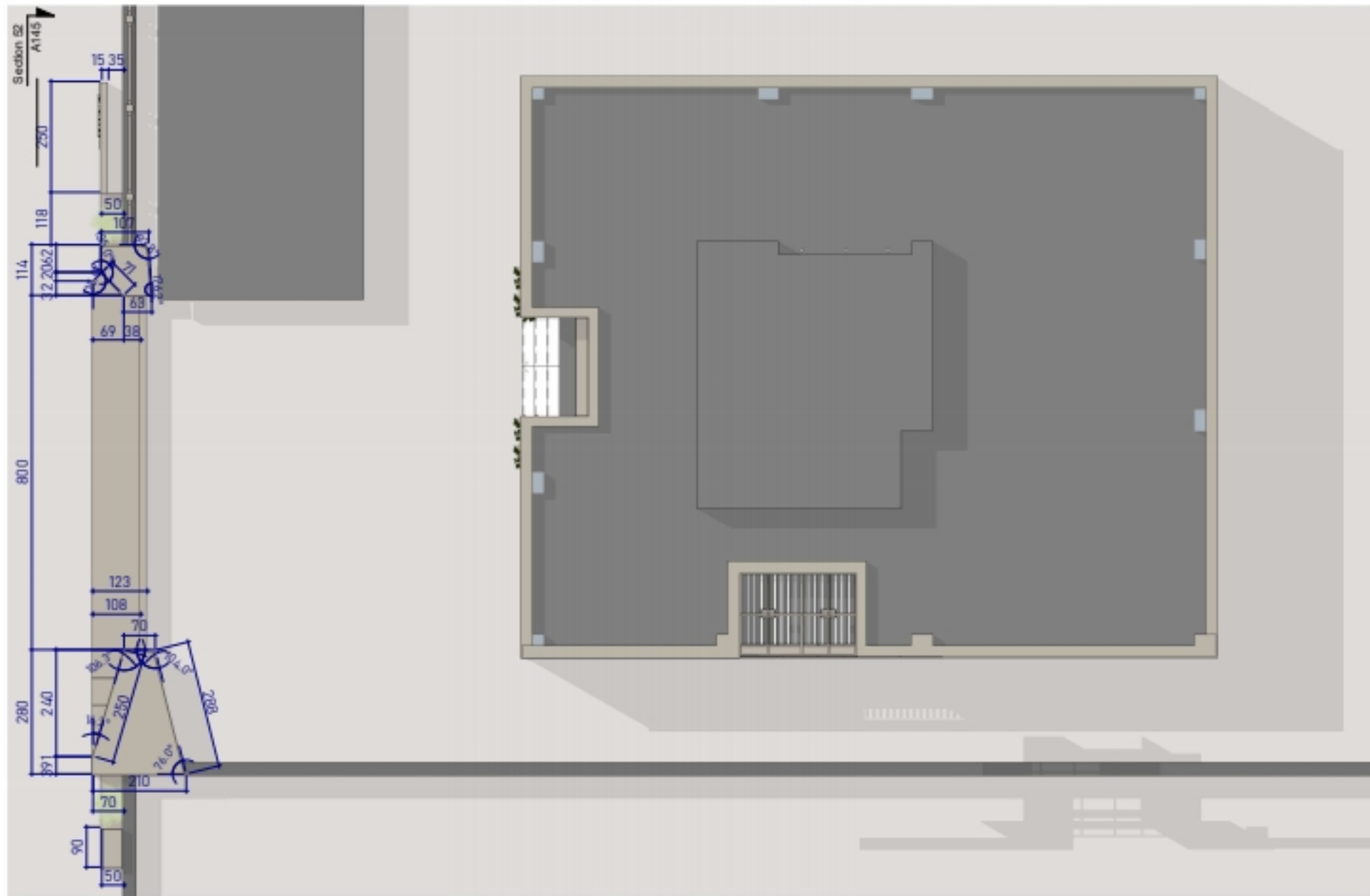

1. SITE PLAN

1 : 100

PROJECT NAME : PAYARAVANKARAN Office

CLIENT : **PAYA RAVANKARAN ALBORZ**

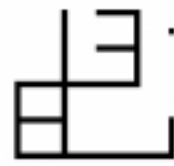

ARCHITECT : MAHSA RAHMATI

ABSAB ARCHITECTURAL DESIGN & CONSTRUCTION TEAM

SITE PLAN

Project number

Date

Drawn by

Paper Size :

Issue Date

A3

Scale

A144

No.	Description	Date

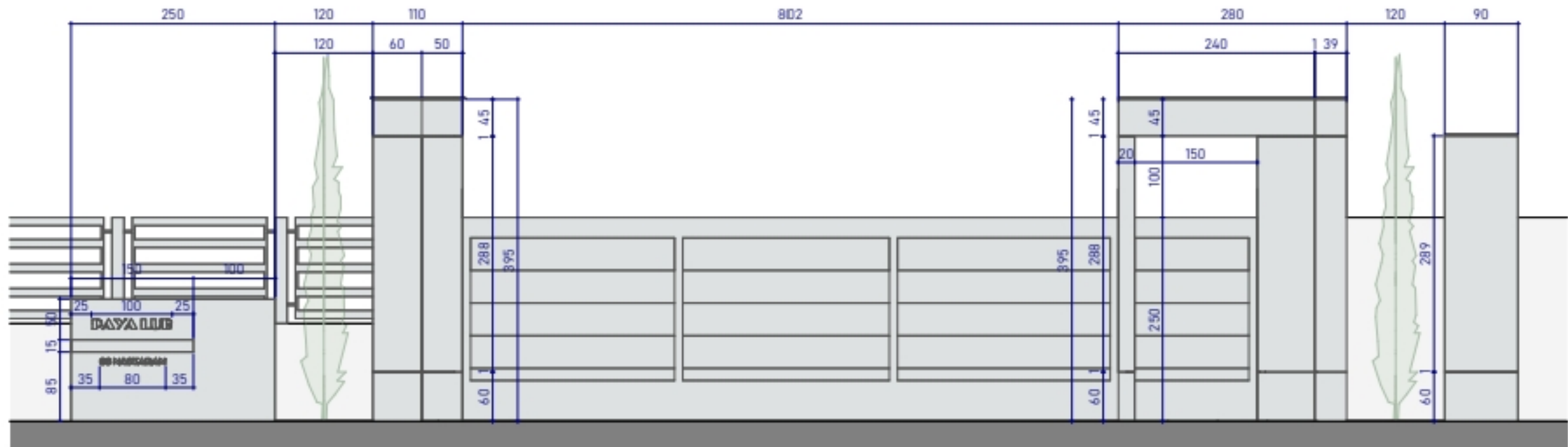

1 - SECTION 52

1 : 50

PROJECT NAME : PAYARAVANKARAN Office

CLIENT : **PAYA RAVANKARAN ALBORZ**

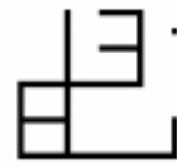

ARCHITECT : MAHSA RAHMATI

ABSAB ARCHITECTURAL DESIGN & CONSTRUCTION TEAM

MAIN ENTRANCE

Project number
Date Issue Date
Drawn by
Paper Size : A3

A145

Scale

No.	Description	Date



Absab.Studio@gmail.com
ARCHITECTURE & CONSTRUCTION